



Nukurusar aujsar aarar unuimiartai

Aprendamos las letras jugando
en lengua Achuar Chicham

DISTRIBUCIÓN GRATUITA - PROHIBIDA SU VENTA

MINISTERIO
DE EDUCACIÓN



EL
GOBIERNO
DE TODOS



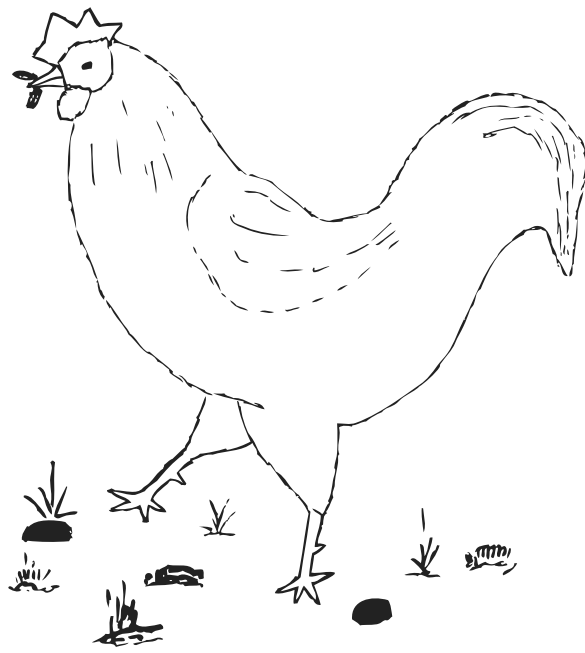

atash

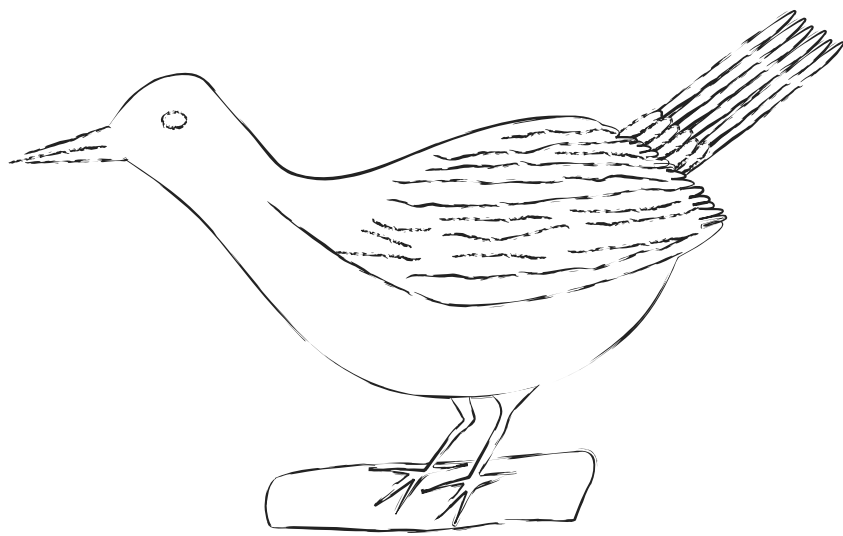

chuwi

S
i
m
a

E
M
K
e
a
u
sh

K^m sh u t y sh E i S M^a y K s M



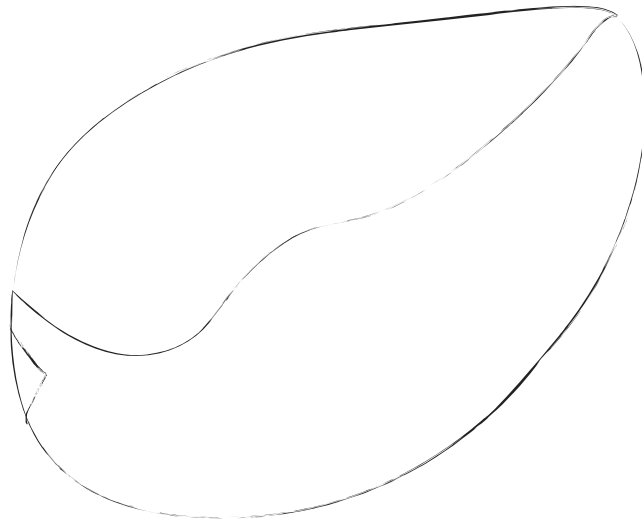

etse



ipiak

E

M

K_e

a

u

sh

S

i

m

a

K^m

sh

u

t

y

sh

E

i

S

M

a

y

K

s

M



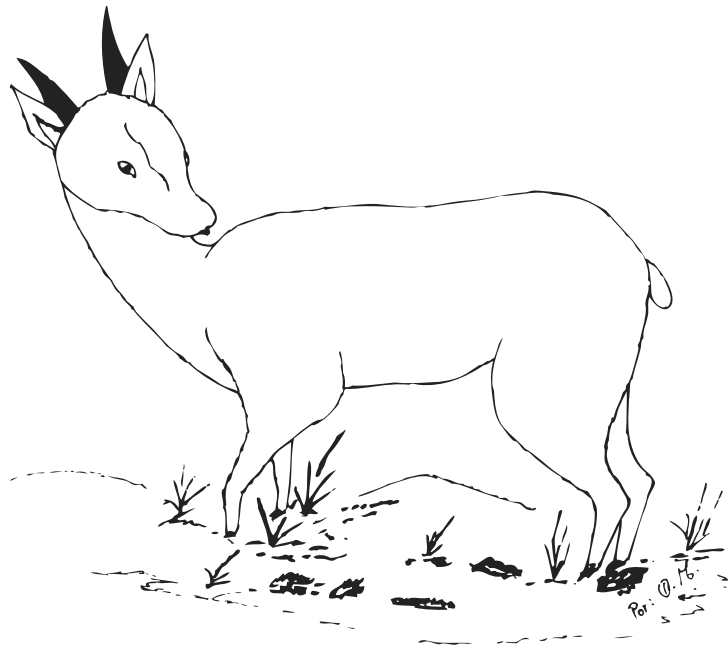

japa



kawau

S
i
m
a

E
M
K
e
a
u
sh



mama

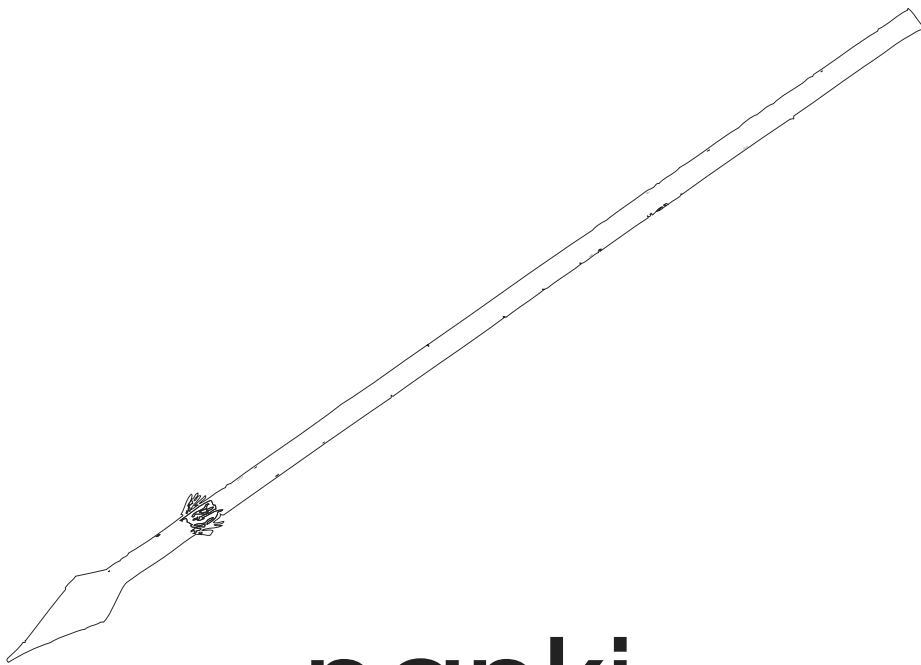

nanki

S
i
m
a

E
M
K
e
a
u
sh

K^m sh u t y sh E i S M^a y K s M  

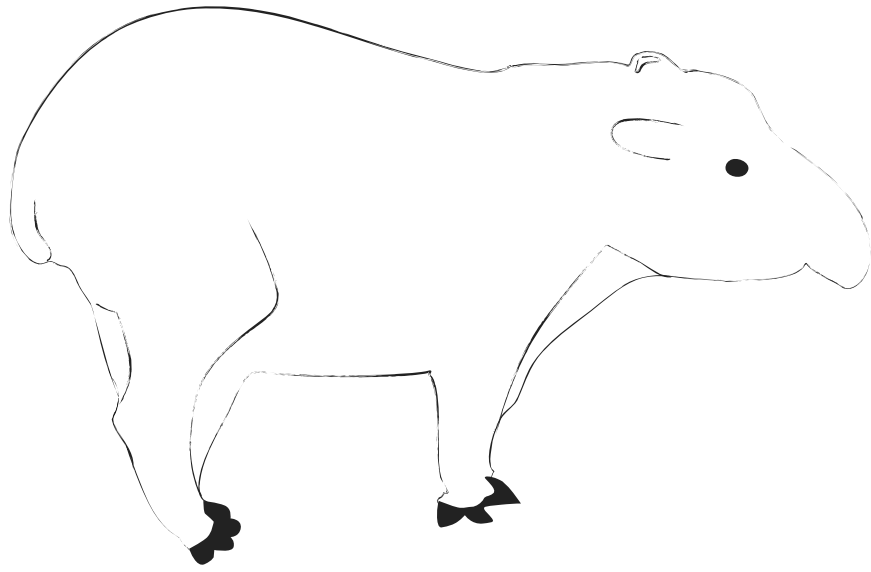

pama

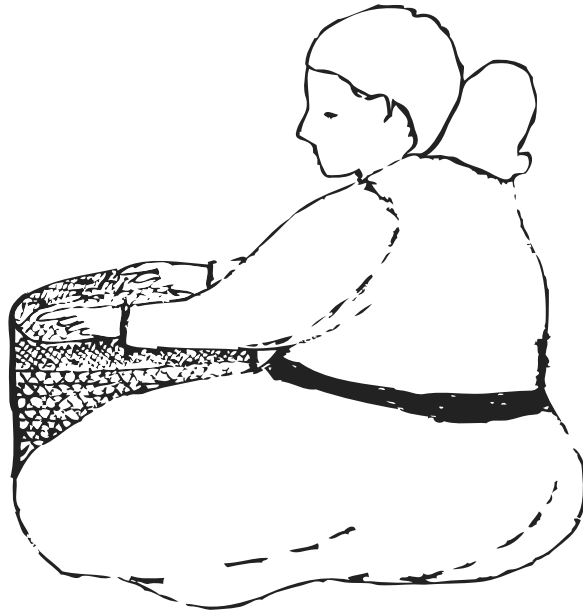

ramian

S
i
m
a

E
M
K
e
a
u
sh

K^m sh u t y sh E i S M^a y K s M





sawa

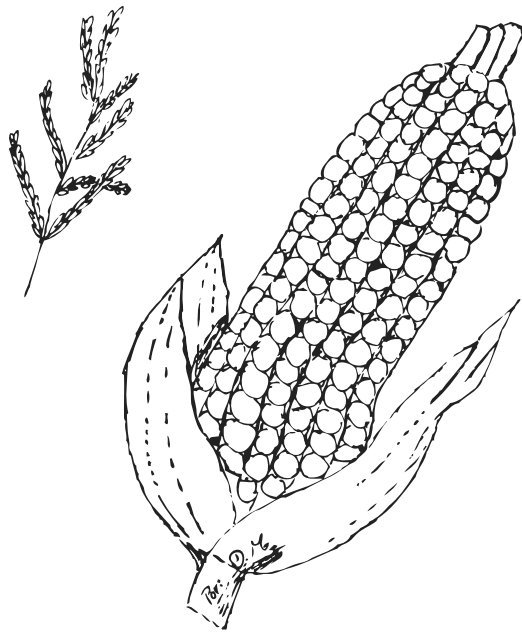

shaá

s
i
m
a

E
M
K
e
a
u
sh

K^m
sh u t y sh E i S m a y K s M



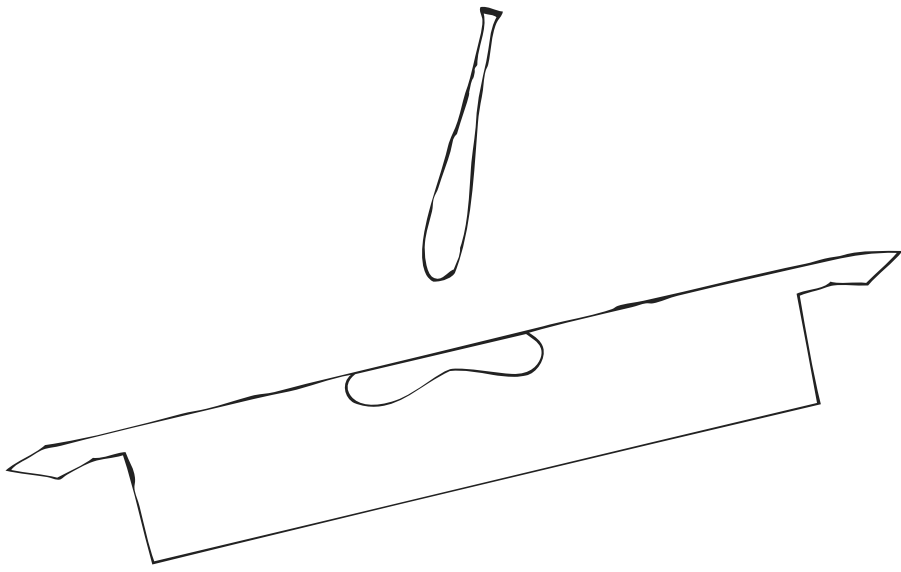

tuntui

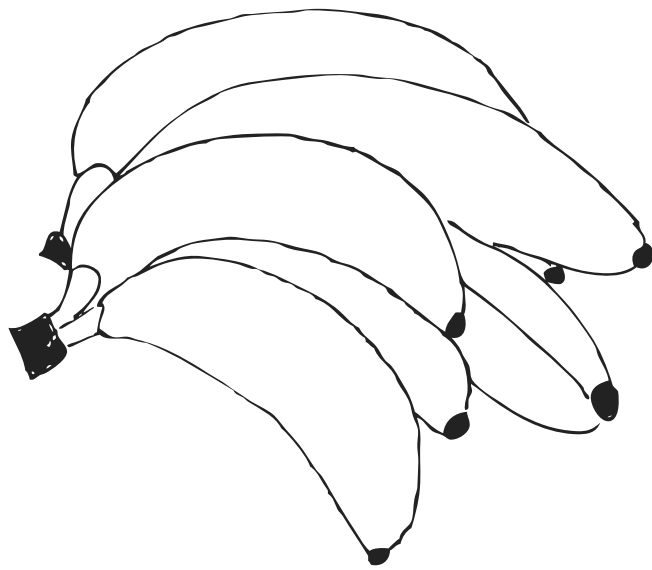

tsamau

S
i
m
a

E
M
K
e
a
u
sh



uwej

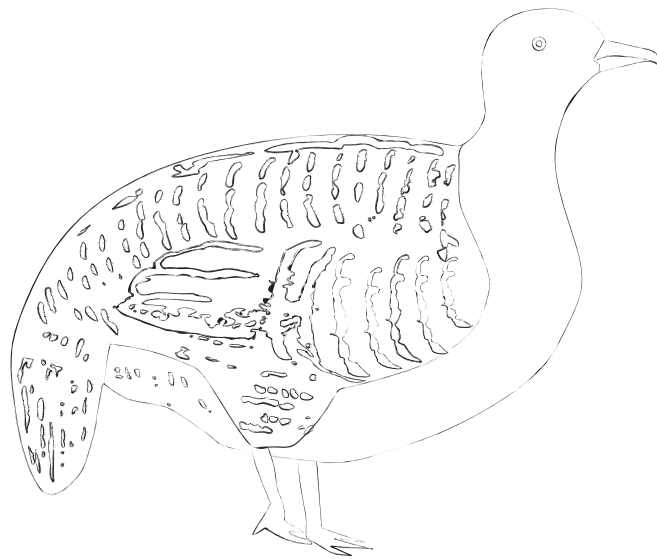

waa

S
i
m
a

E
M
K
e
a
u
sh

K^m sh u t y sh E i S M^a y K s M



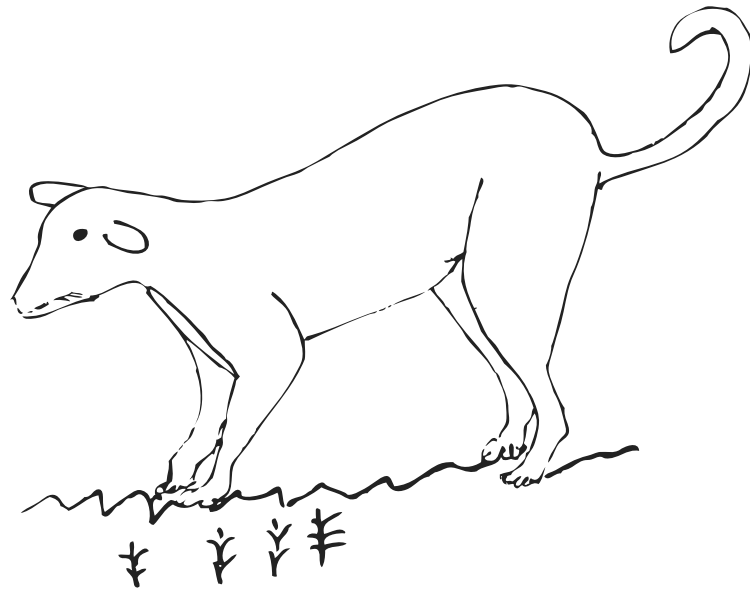

yawa

Large empty rectangular box for writing or drawing.

Two smaller empty rectangular boxes at the bottom of the page.

S
i
m
a

E
M
K
e
a
u
sh

Q

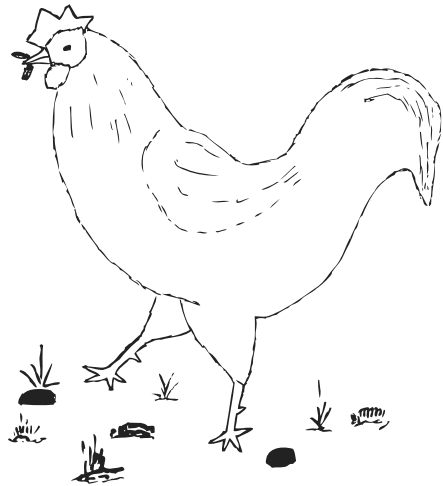

atash

atash

i s
m
a

E
M
K e
a
u
sh

K m
sh u t y sh E i S m a y K s M



ch

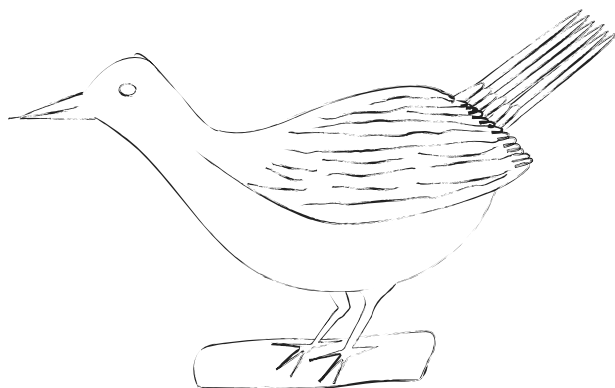

chuwi

chuwi

E
M
K
e
a
u
sh

K^m sh u t y sh E i S M^a y K s M



e

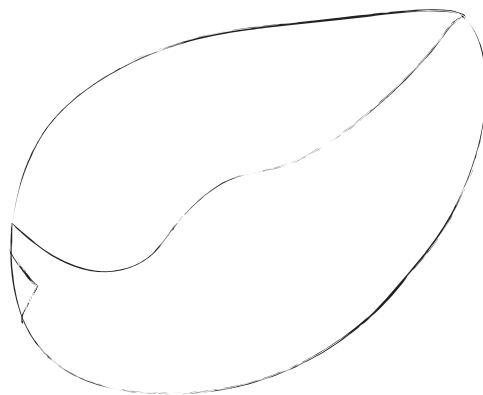

etse

etse

i s
m
aE
M
K e
a
u
shK m
sh u t y sh E i S m a y K s M

i



ipiak

ipiak

E
M
K
e
a
u
shK^m
sh u t y sh E i S M^a y K s M

j

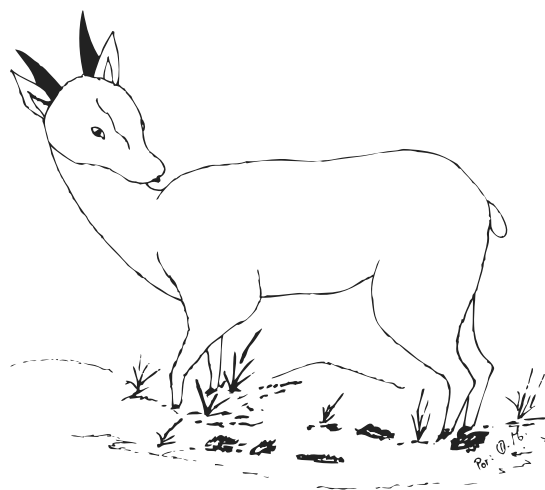

japa

j a p a

s
i
m
a

E
M
K
e
a
u
sh

K m
sh u t y sh E i S m a y K s M



k



kawau

kawau

E
M
K
e
a
u
sh

K^m sh u t y sh E i S M^a y K s M



m



mama

m a m a

S
i
m
a

E
M
K
e
a
u
sh

K^m
sh u t y sh E i S M^a y K s M



n

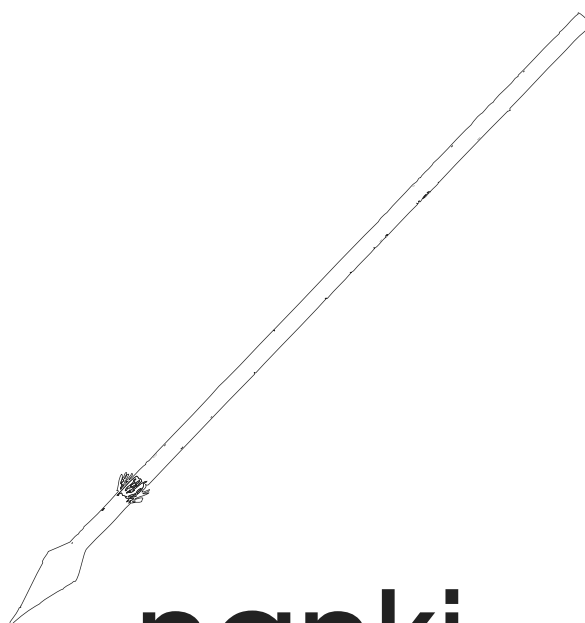

nanki

nanki

E
M
K
e
a
u
sh

K^m sh u t y sh E i S M^a y K s M



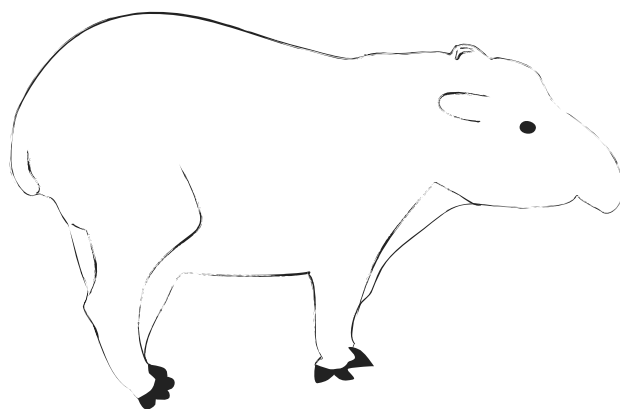
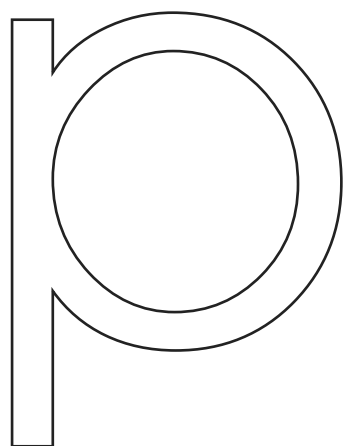

pama

p a m a

s
i
m
a

E
M
K
e
a
u
sh

sh K m u t y sh E i S m a y K s M



r

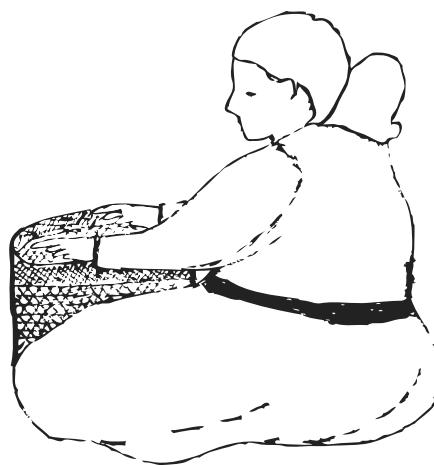

ramian

ramian

s

i

m

a

K^m

sh

u

t

y

sh

E

i

S

M

a

y

K

s

M



E

M

K^e

a

u

sh

S



sawa

sawa

s
i
m
a

E
M
K
e
a
u
sh

sh K m u t y sh E i S m a y K s M



Sh

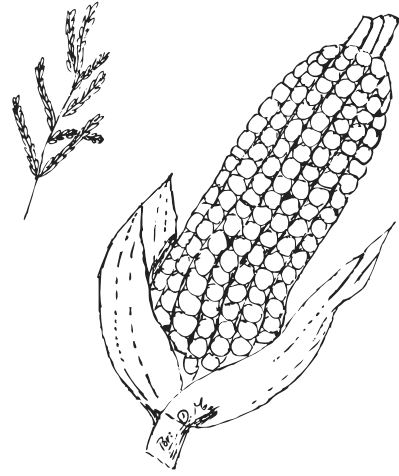

shaá

shaá

E

M

Ke

a

u

sh

S

i

m

a

K m

sh

u

t

y

sh

E

i

S

M

a

y

K

s

M



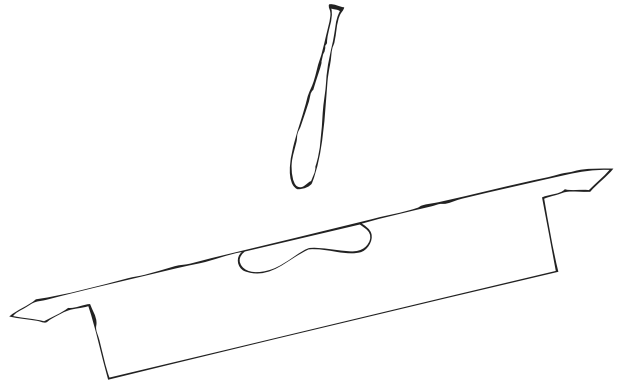
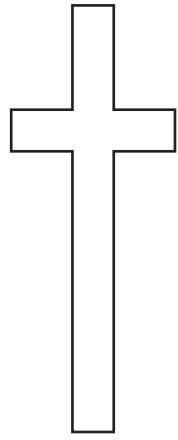

tuntui

tuntui

i s
i
m
a

E
M
K e
a
u
sh

K m
sh u t y sh E i S M a y K s M



ts

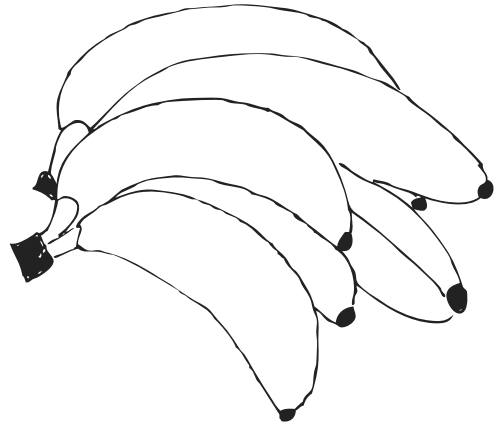

tsamau

tsamau

i s
m
a

E
M
K e
a
u
sh

K m
sh u t y sh E i S m a y K s M



u



uwej

u w e j

i s
m
a

E
M
K e
a
u
sh

K m
sh u t y sh E i S m a y K s M



w

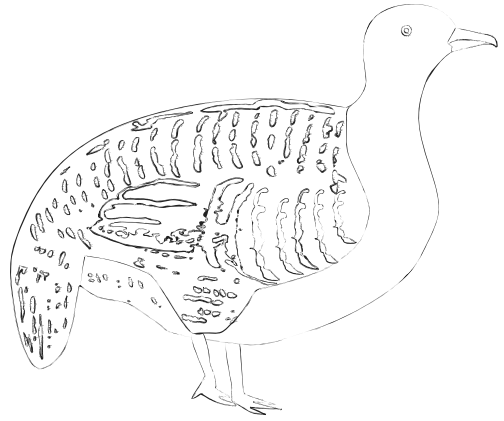

waa

w a a

s
i
m
a

E
M
K
e
a
u
sh

K m
sh u t y sh E i S m a y K s M



y

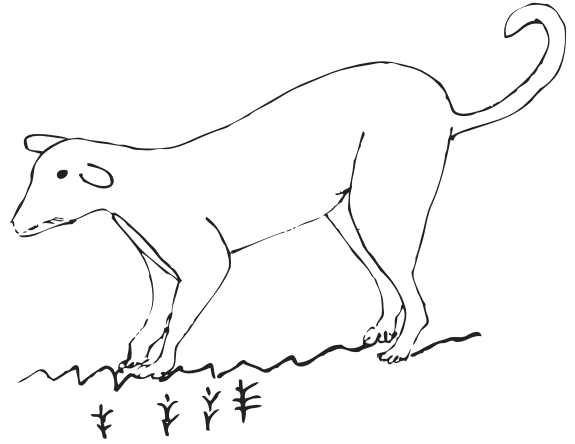

yawa

yawa

S
i
m
a

E
M
K
e
a
u
sh

K^m sh u t y sh E i S M^a y K s M



Q

A

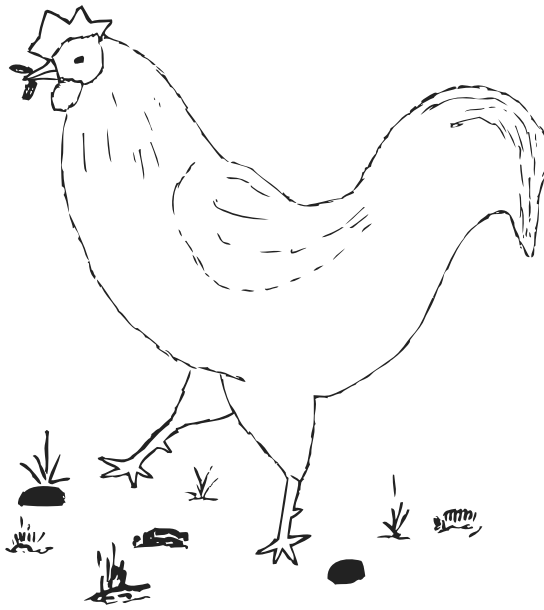

ataş

E

M

K e

a

u

sh

S

i

m

a

K m

sh

u

t

y

sh

E

i

S

M

a

y

K

s

M



ch

CH

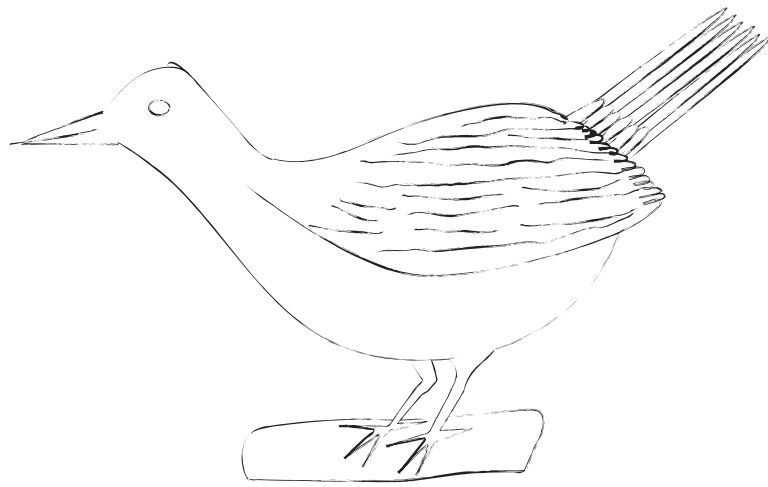

chuwi

s
i
m
a

E
M
K
e
a
u
sh

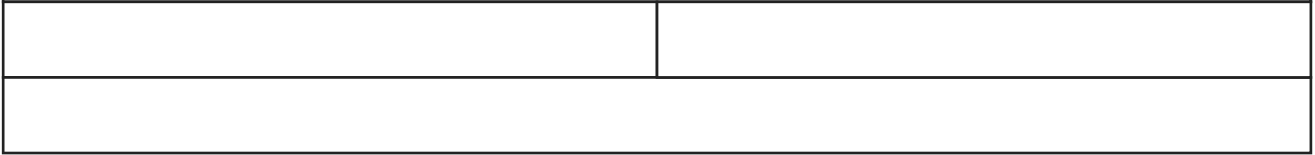
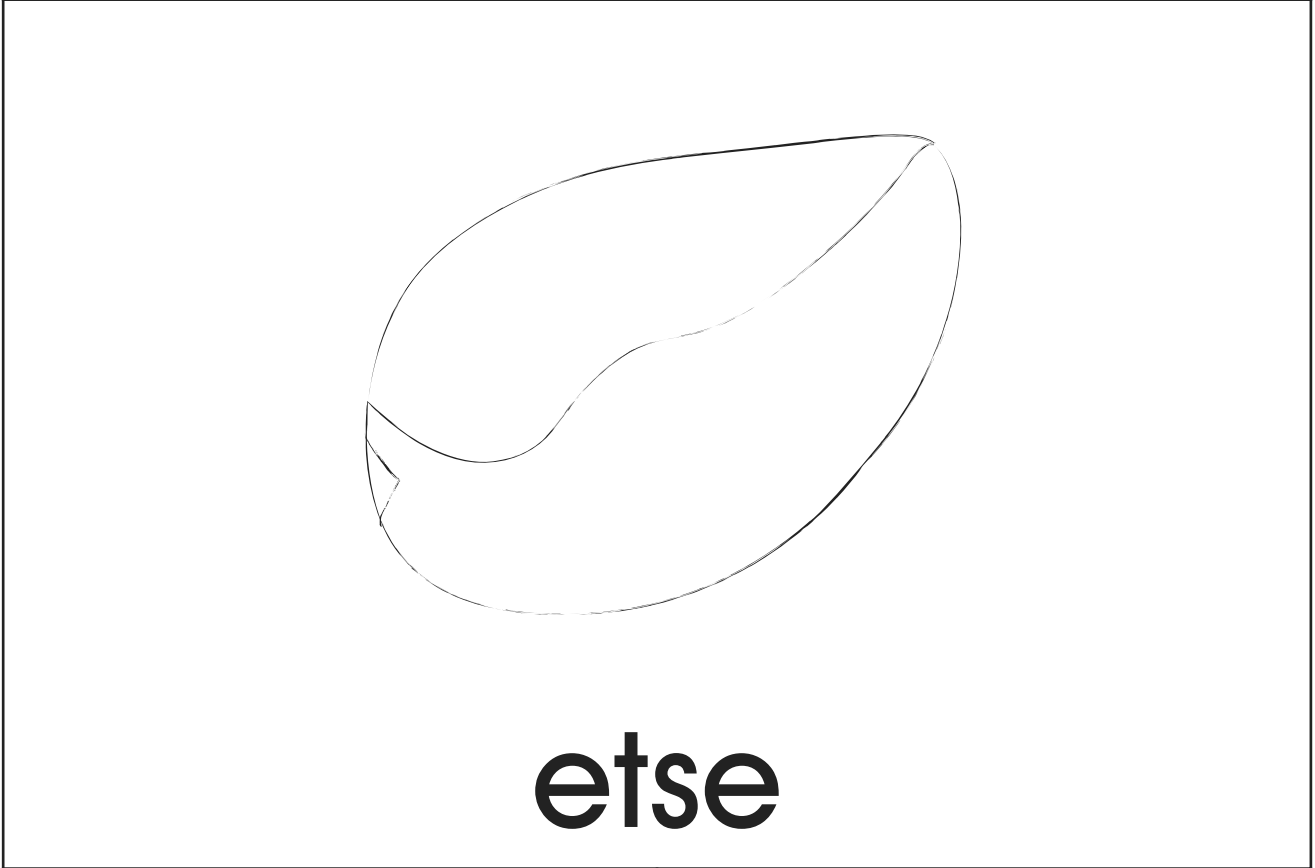
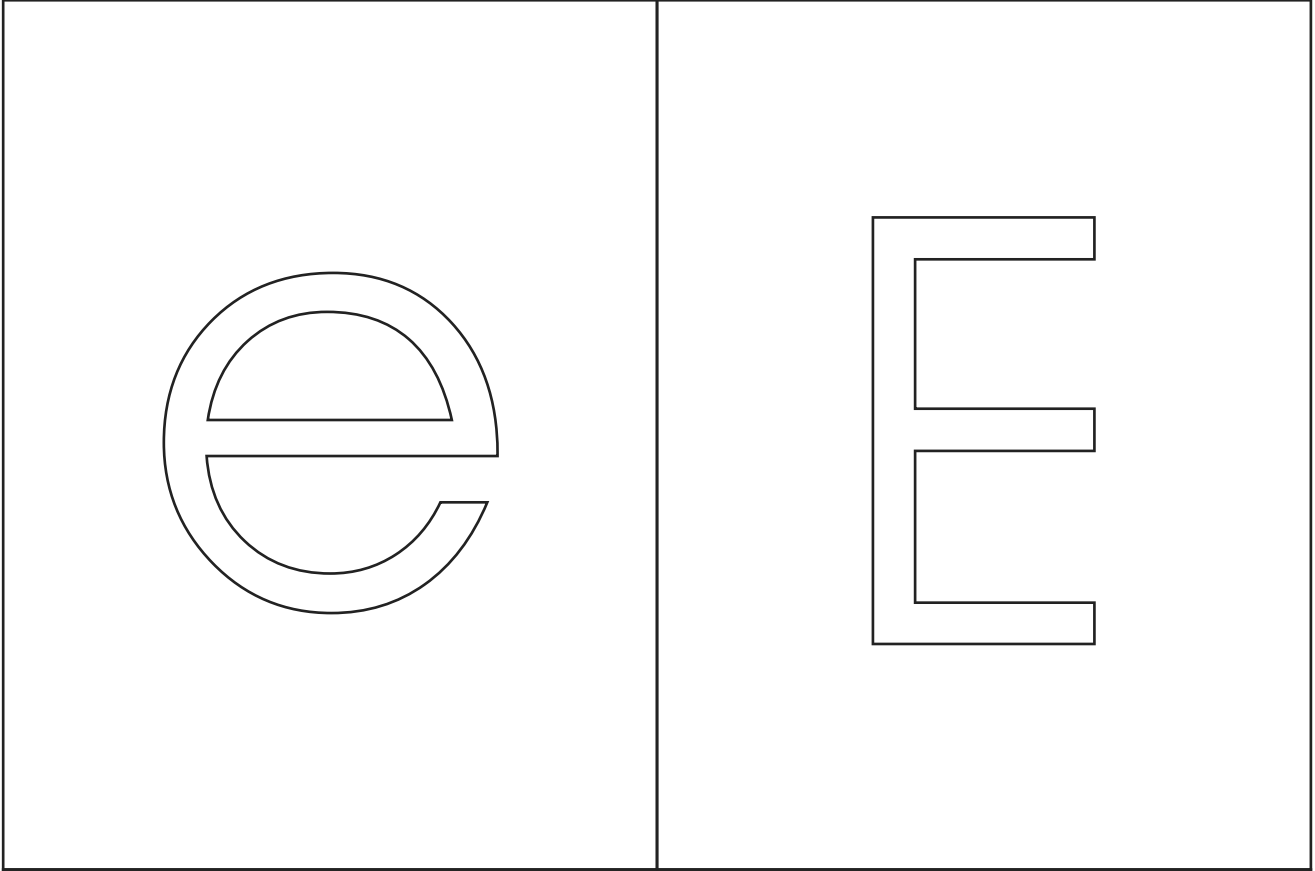

E
M
K
e
a
u
sh

K^m sh u t y sh E i S M^a y K s M



i

i



ipiak

i s
i m
a

E
M
K e
a
u
sh

j

J

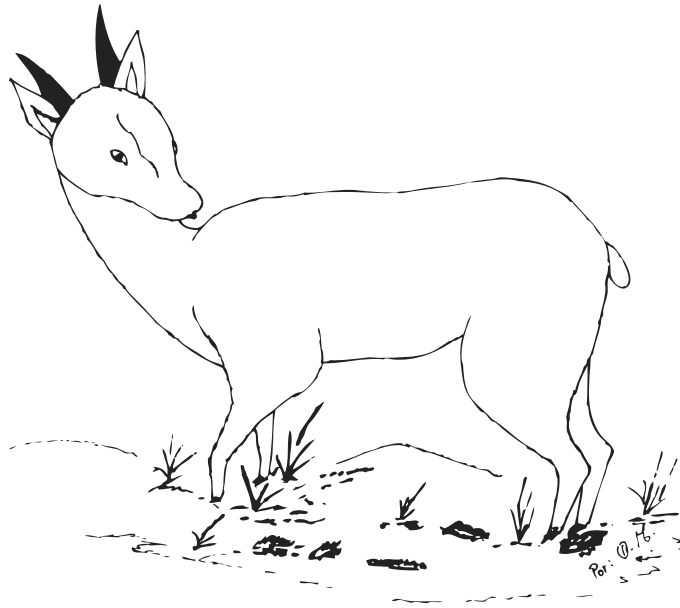

japa

s
i
m
a

E
M
K
e
a
u
sh

sh K m u t y sh E i S m a y K s M  

k

K



kawau

s
i
m
a

E
M
K
e
a
u
sh

sh K m u t y sh E i S m a y K s M 

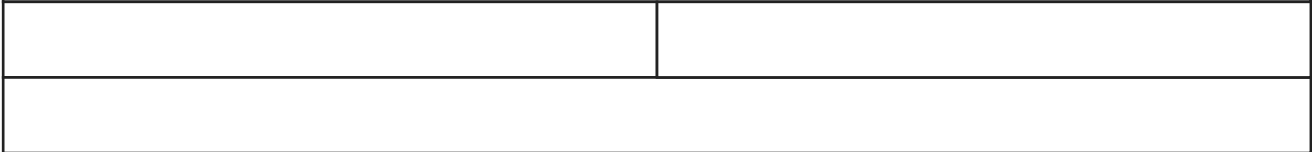
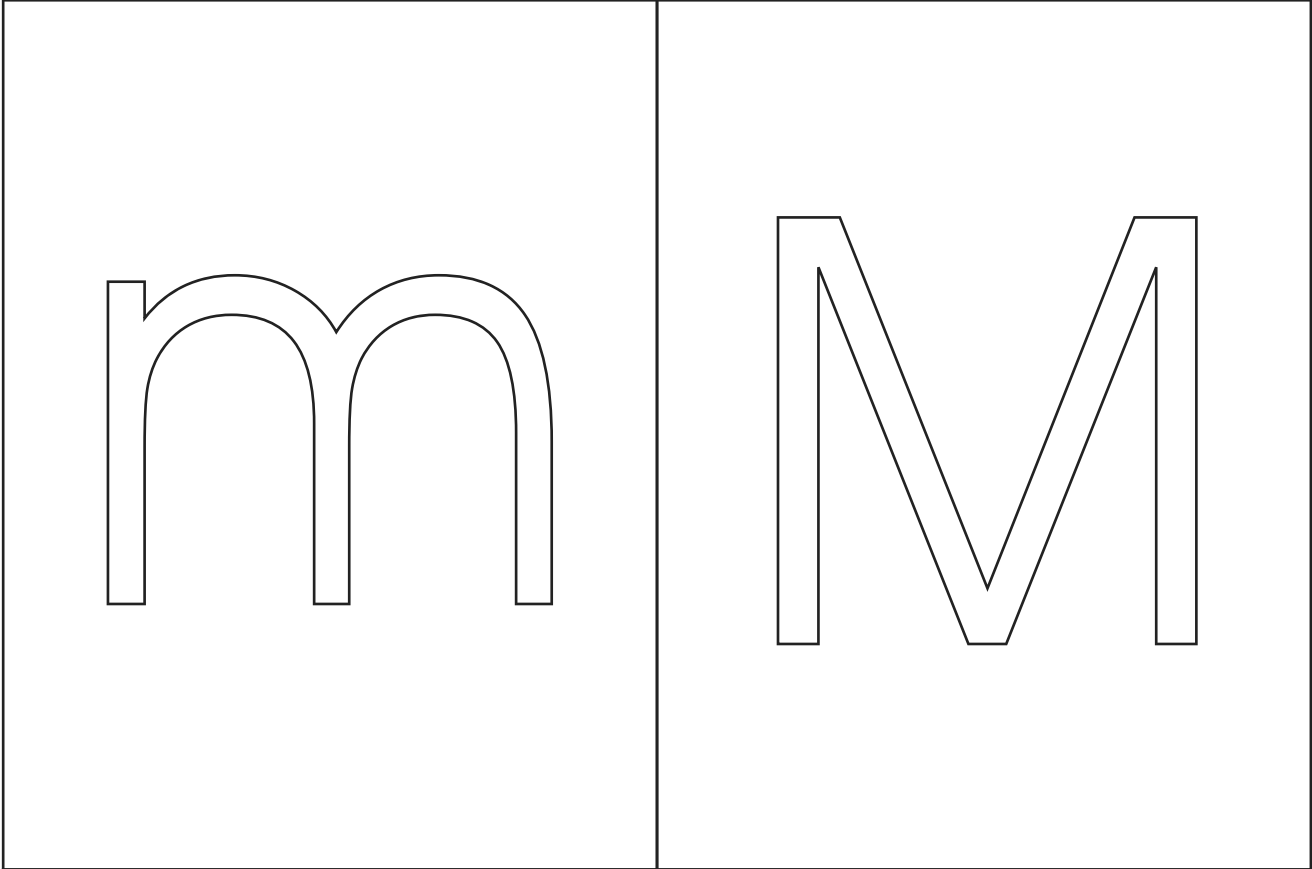

E
M
K
e
a
u
sh

K^m sh u t y sh E i S M^a y K s M



n

N



nanki

S
i
m
a

E
M
K
e
a
u
sh

K^m sh u t y sh E i S M^a y K s M  

p

P

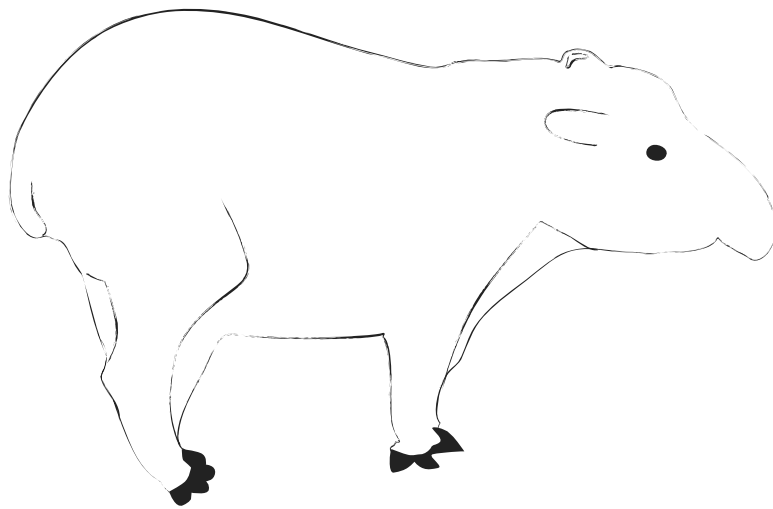

pama

s
i
m
a

E
M
K
e
a
u
sh

r

R

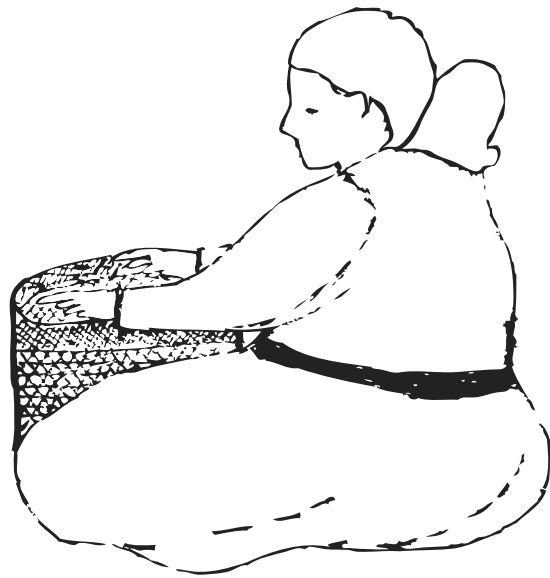

ramian

S
i
m
a

E
M
K
e
a
u
sh

K^m sh u t y sh E i S M^a y K s M 

s

S



sawa

s
i
m
a

E
M
K
e
a
u
sh

sh	SH
----	----

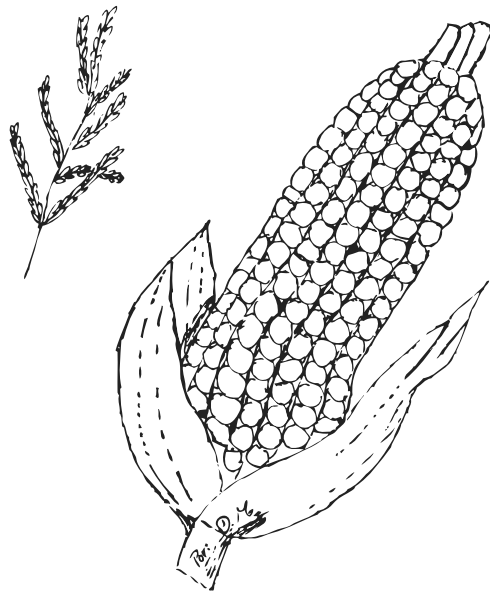

shaá

--	--

E
M
K
e
a
u
sh

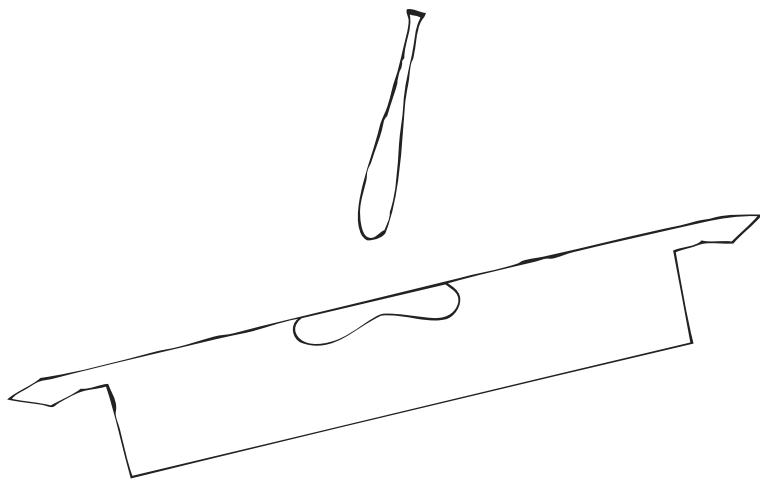
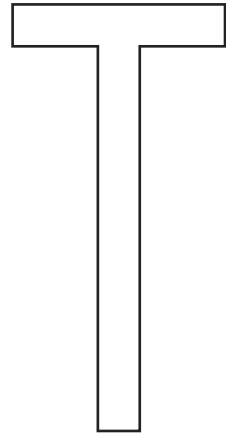
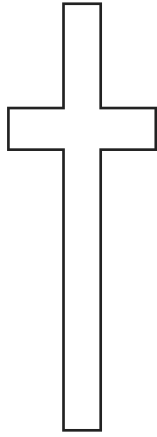

tuntui

S
i
m
a

E
M
K
e
a
u
sh

K^m sh u t y sh E i S M^a y K s M



ts

TS

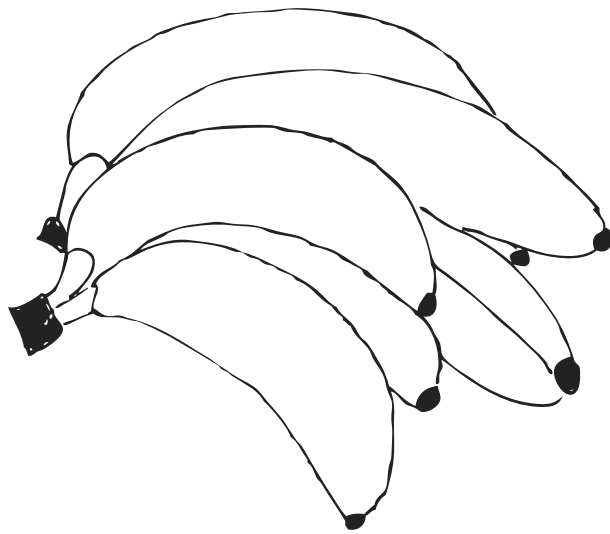

tsamau

s
i
m
a

E
M
K
e
a
u
sh

K^m
sh u t y sh E i S M^a y K s M



u

U



uwej

i s
m
a

E
M
K e
a
u
sh

K m
sh u t y sh E i S m a y K s M



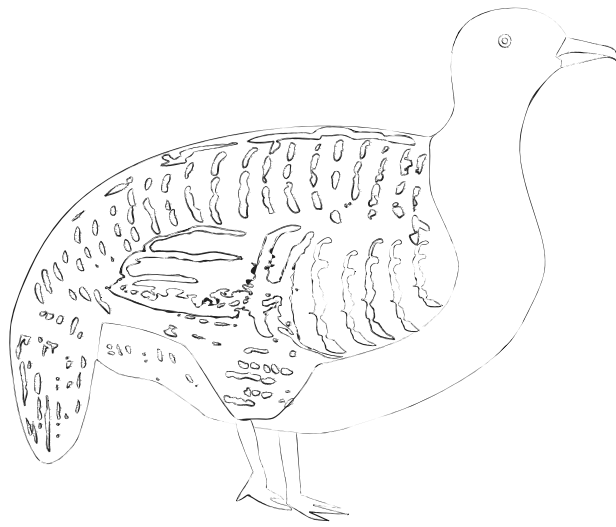
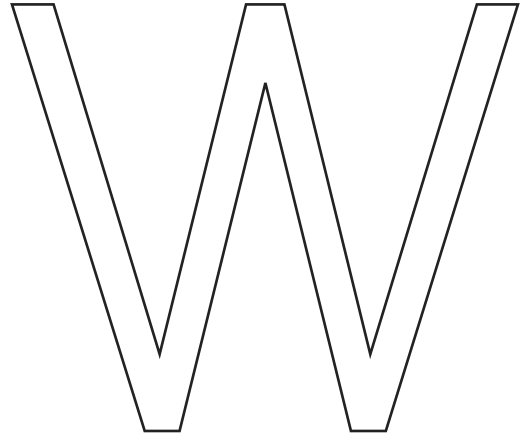
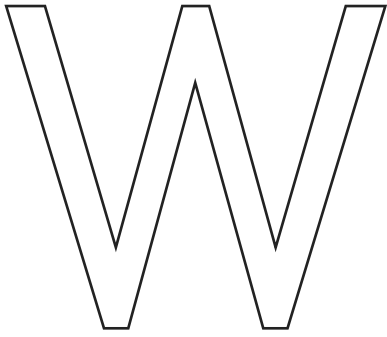

waa

S
i
m
a

E
M
K
e
a
u
sh

K^m sh u t y sh E i S M^a y K s M



y

Y

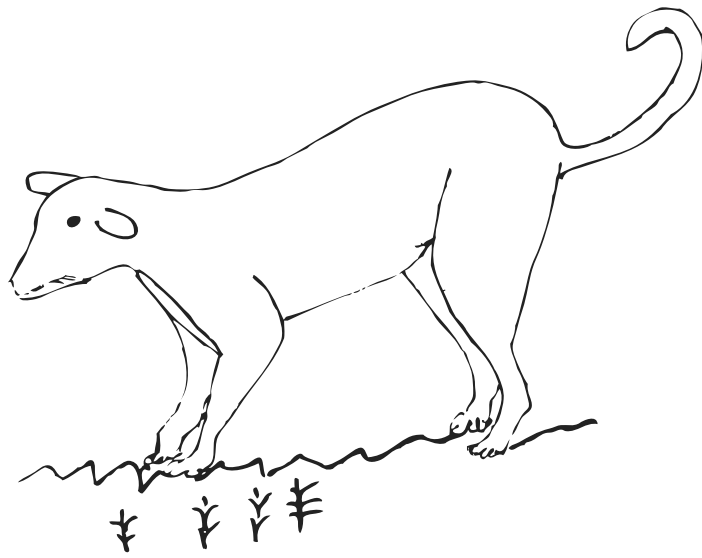

yawa

S
i
m
a

E
M
K
e
a
u
sh

K^m sh u t y sh E i S M^a y K s M  

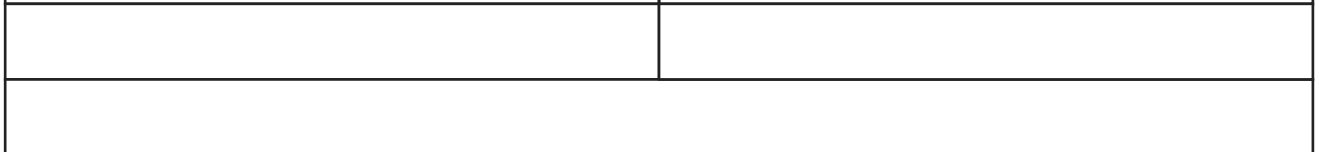
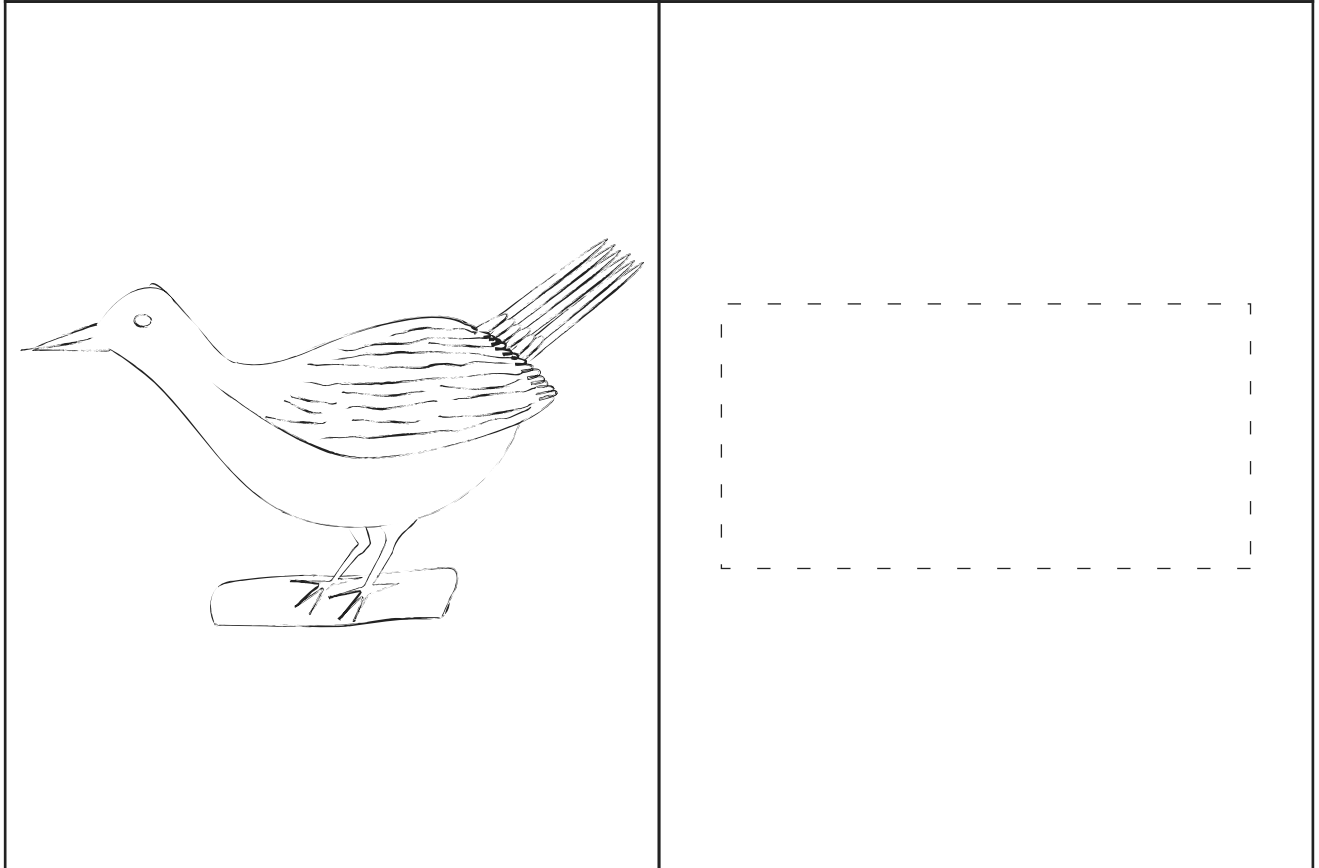
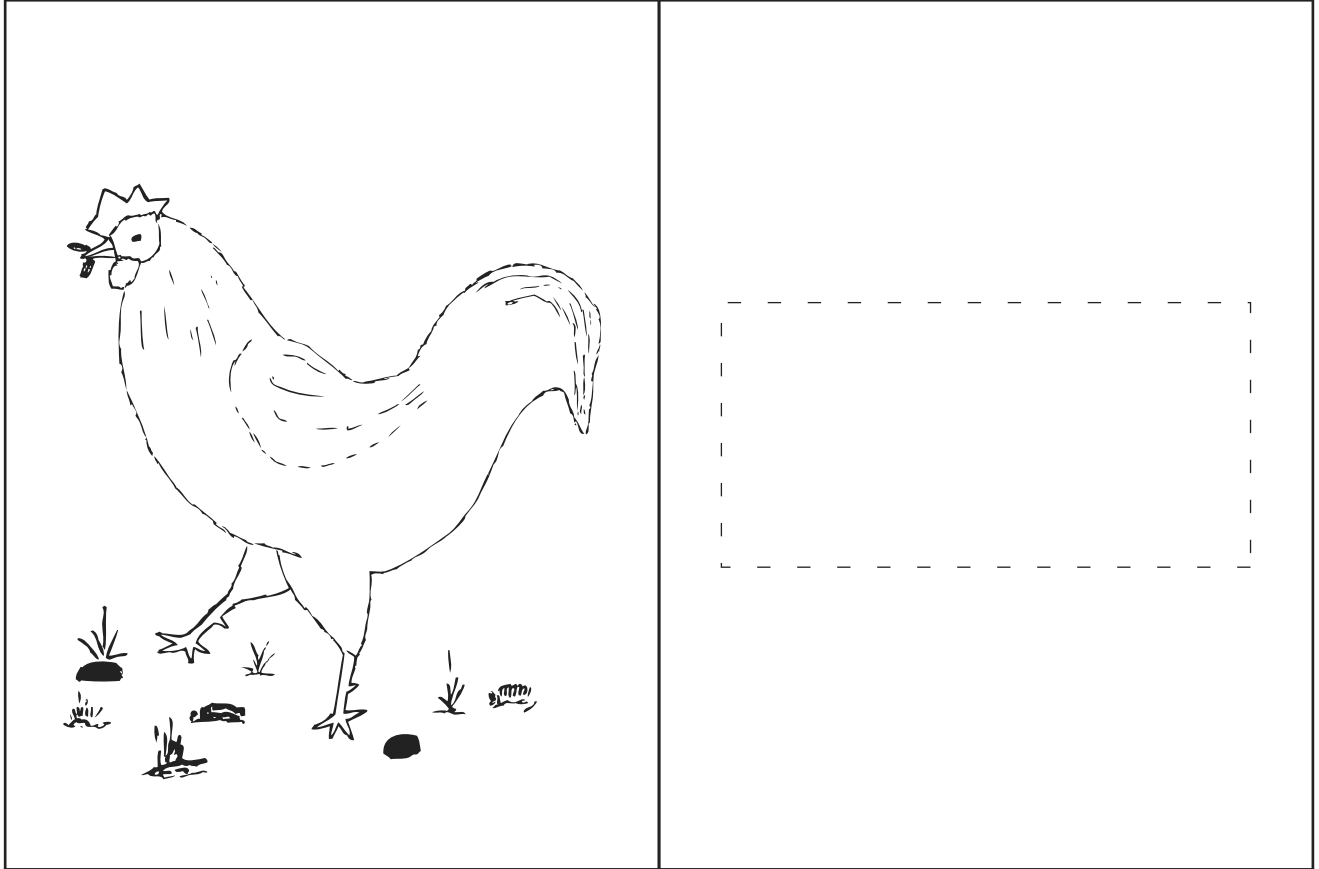

S
i
m
a

E
M
K
e
a
u
sh

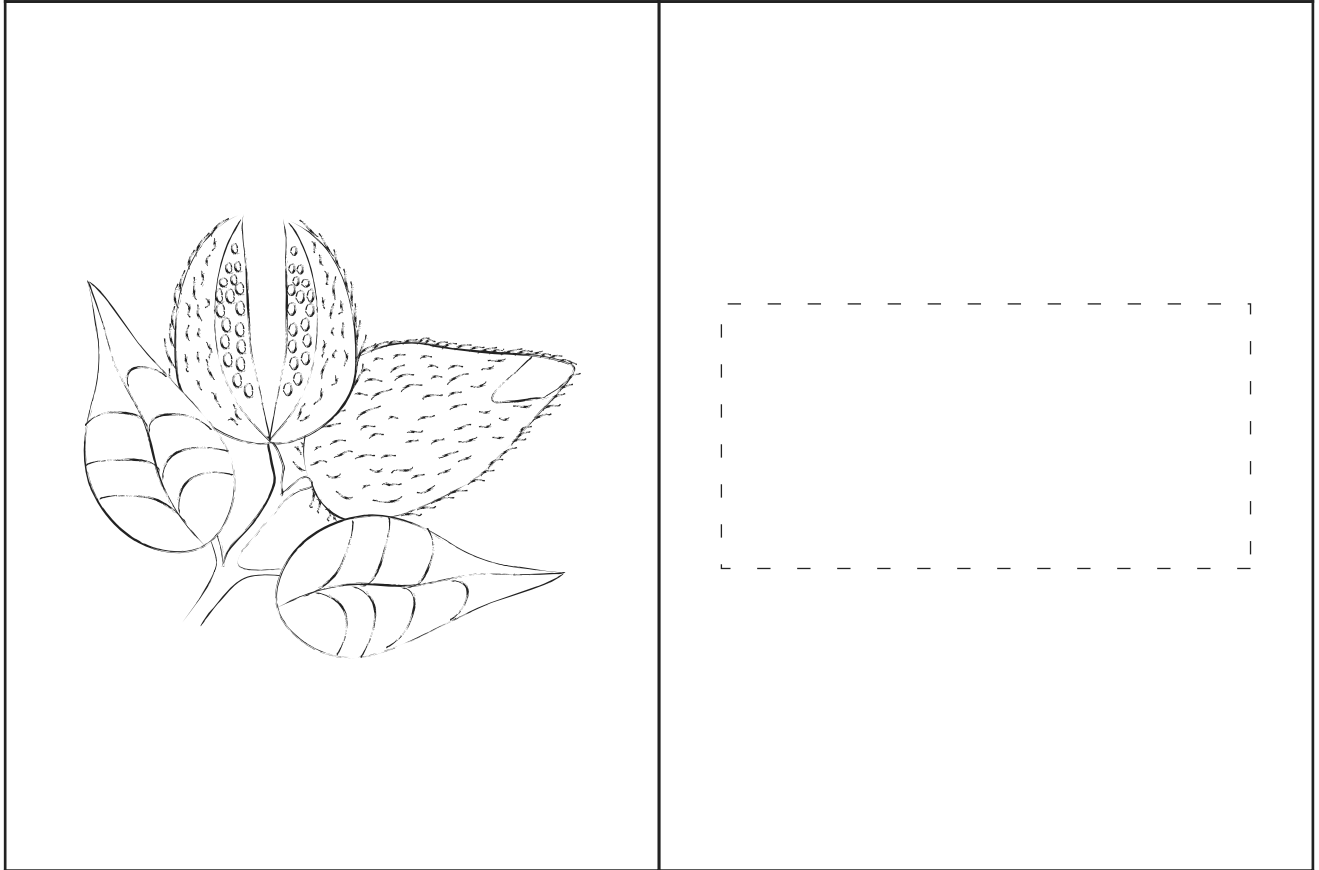
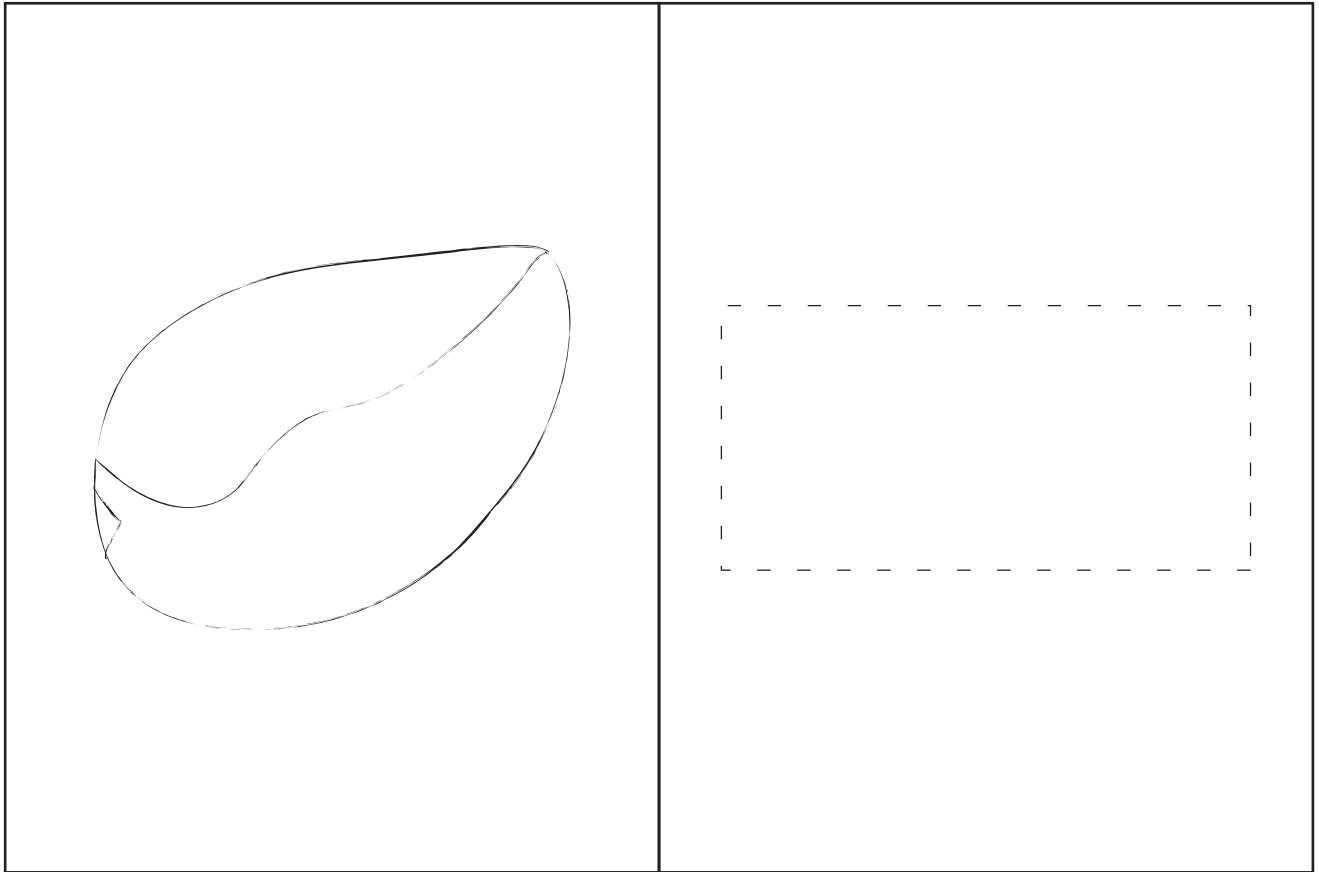

--	--

i s
m
a

E
M
K e
a
u
sh

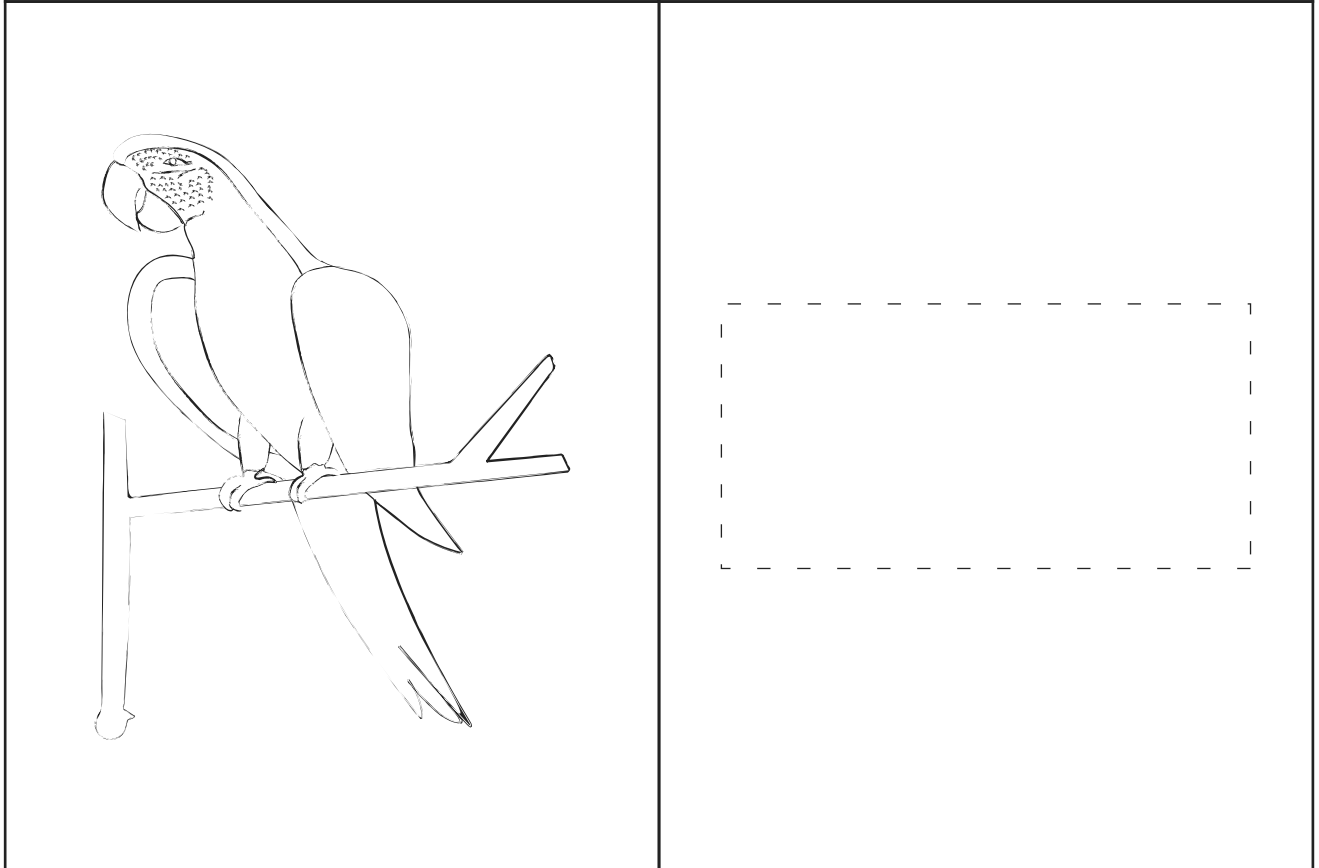
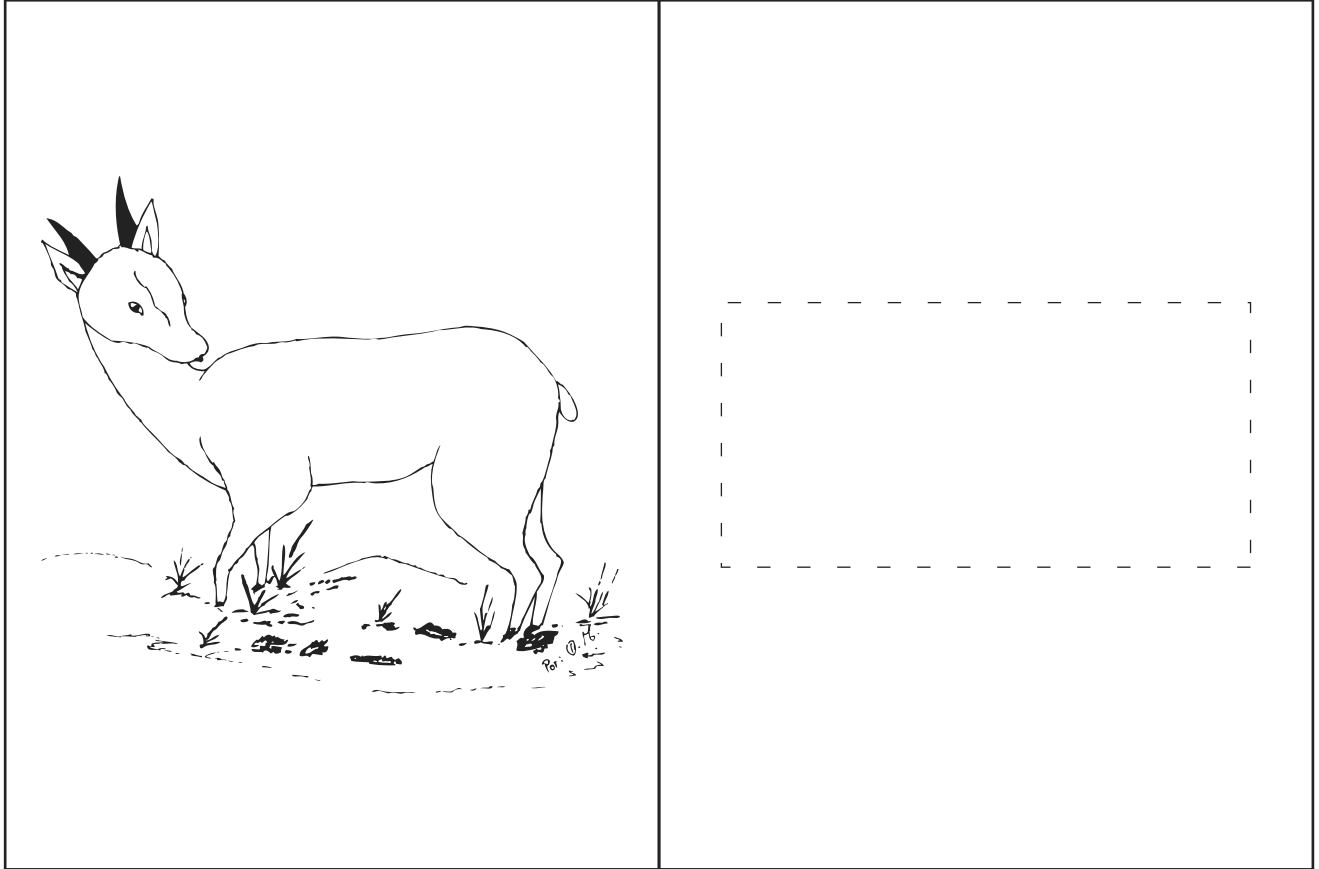

S
i
m
a

E
M
K
e
a
u
sh

sh K^m u t y sh E i S M^a y K s M



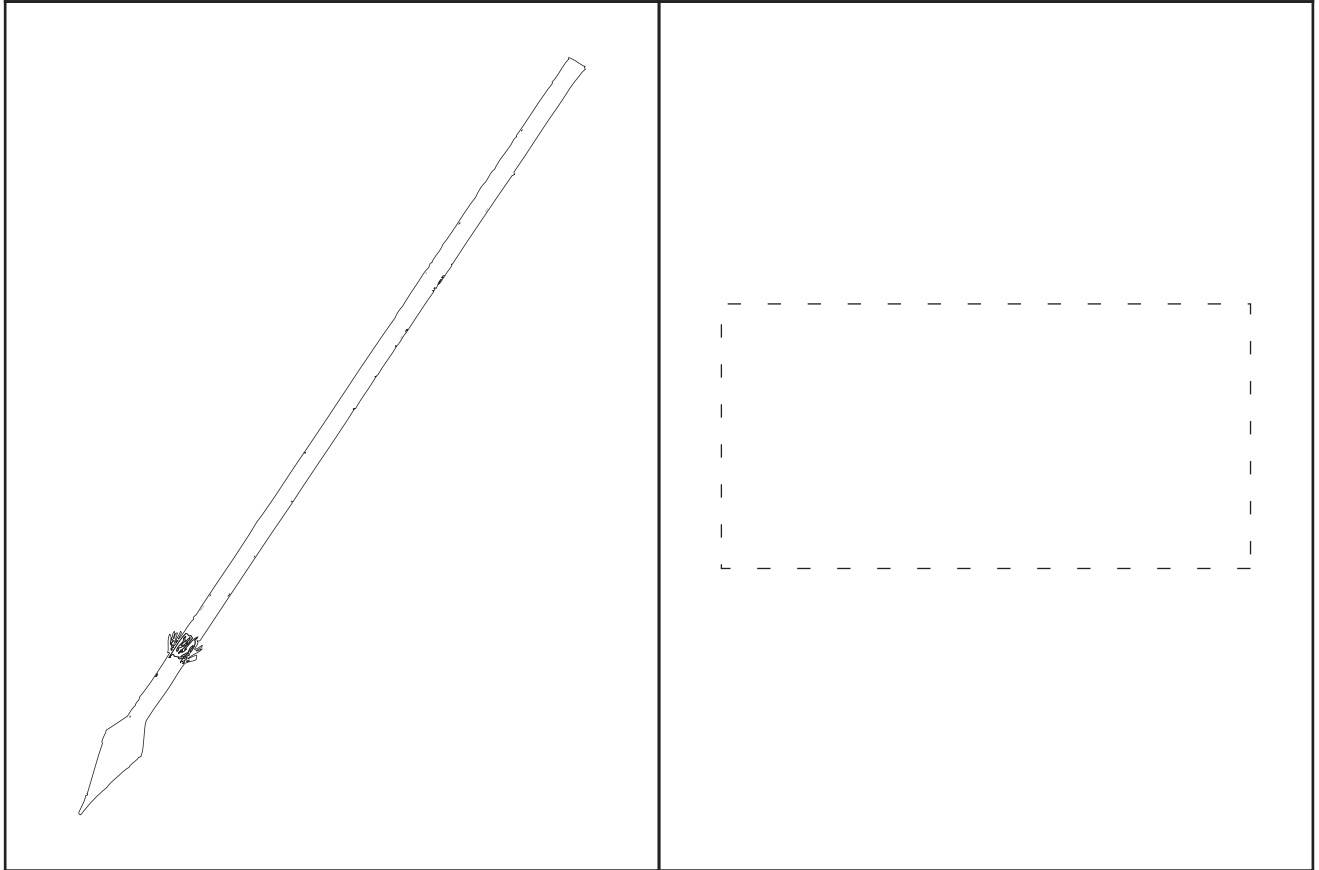
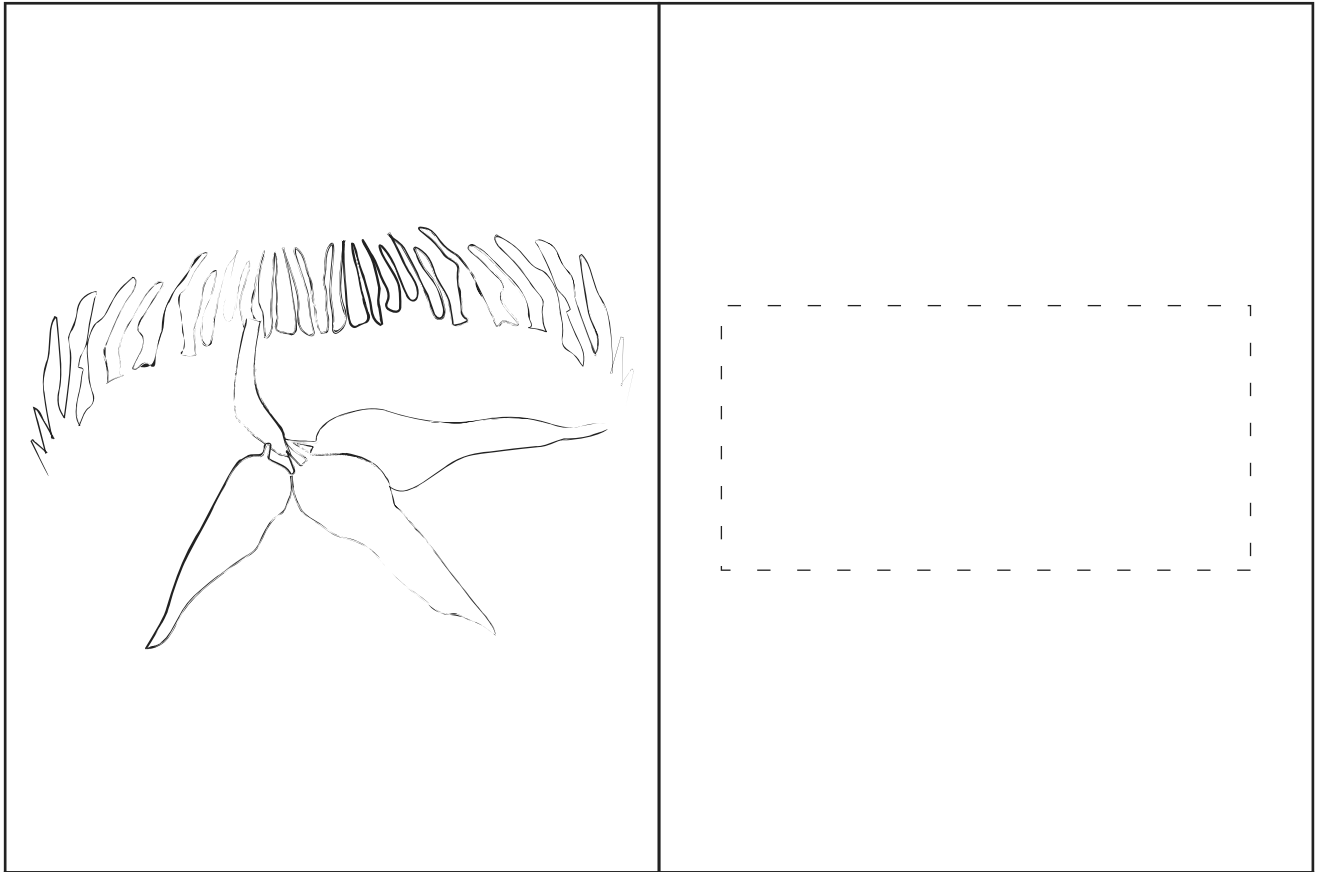

--	--

S
i
m
a

E
M
K
e
a
u
sh

sh K m u t y sh E i S m a y K s M



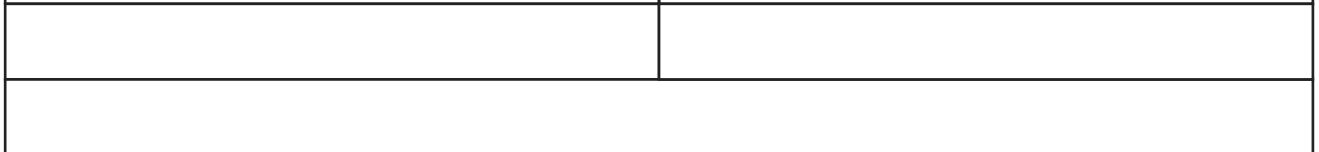
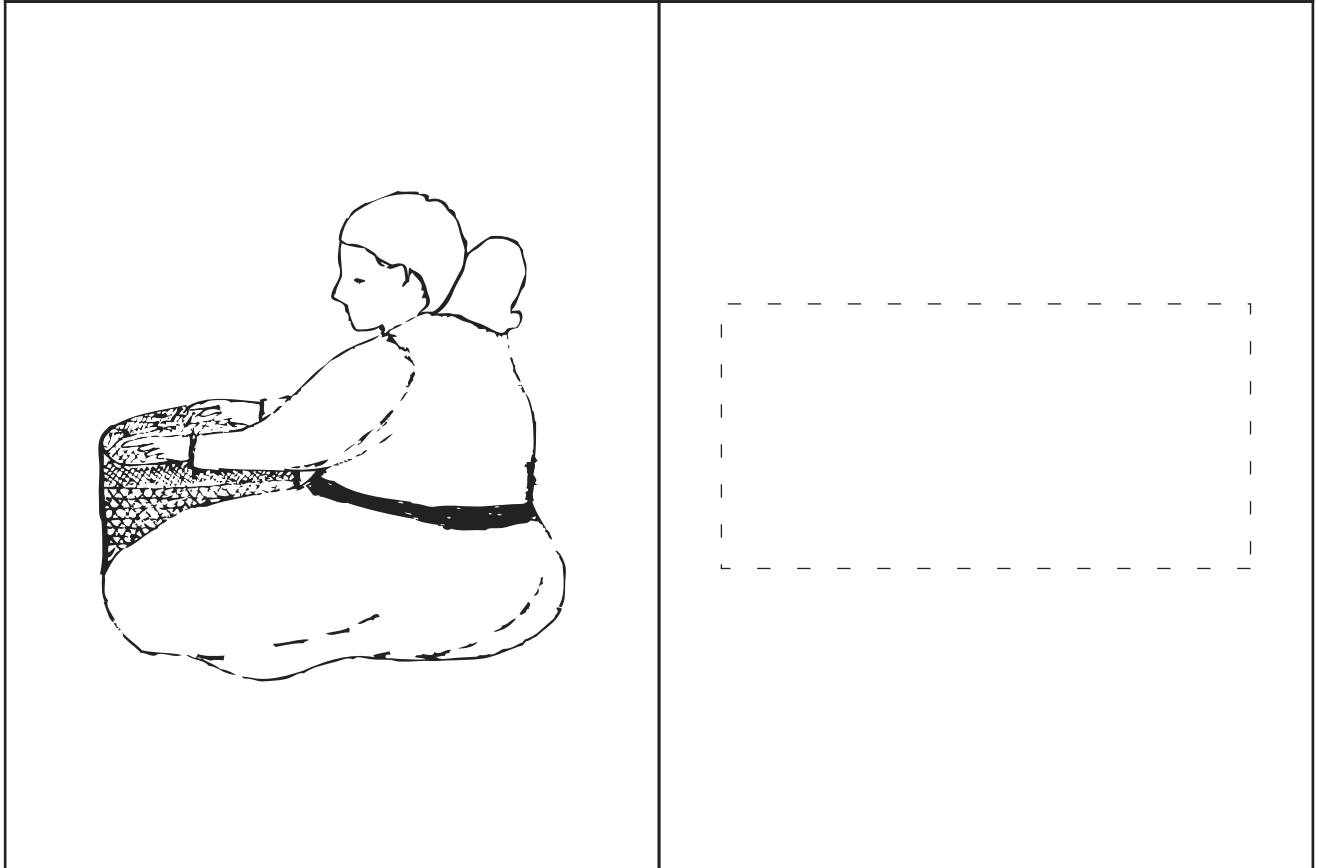
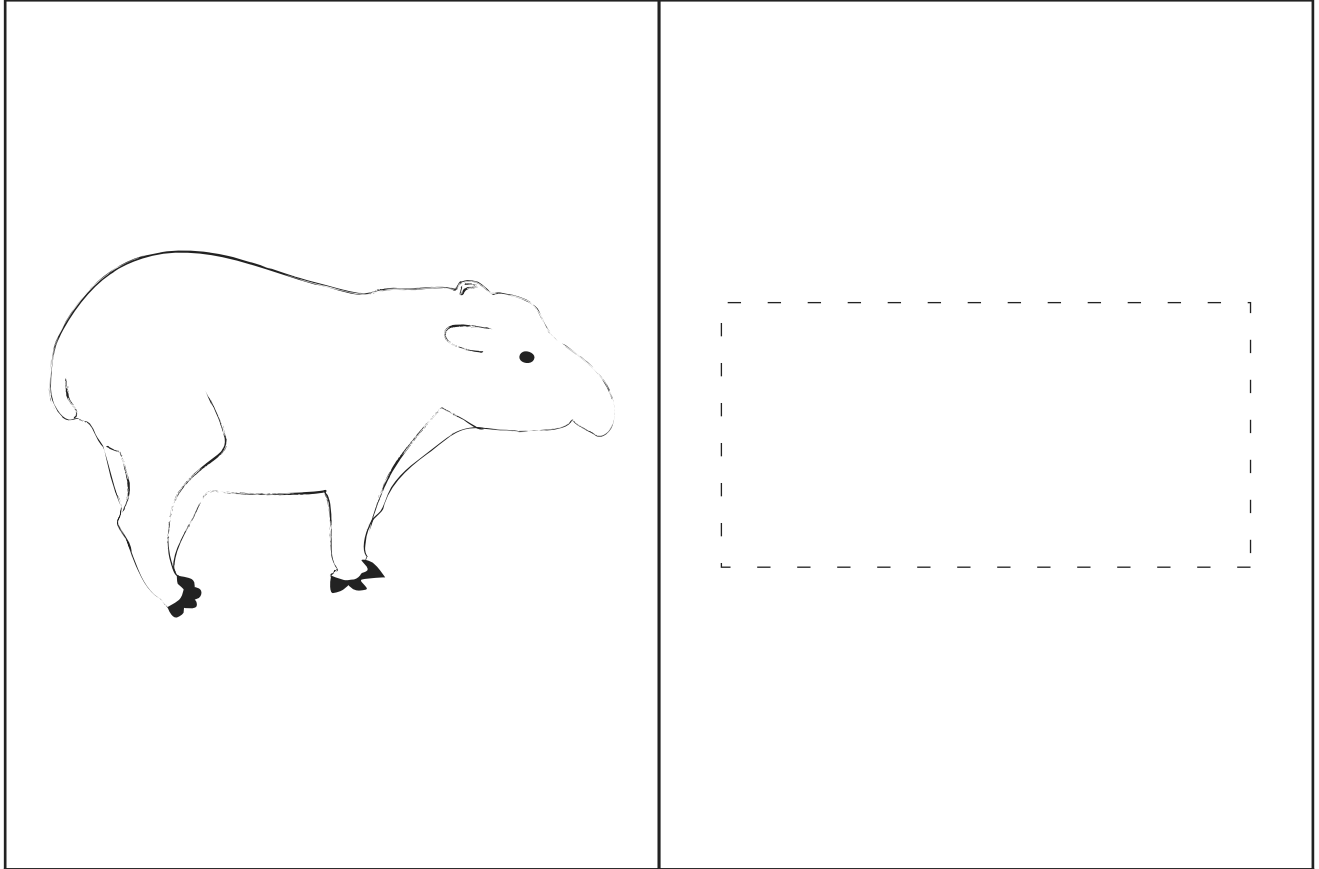

S
i
m
a

E
M
K
e
a
u
sh

sh K^m u t y sh E i S M^a y K s M



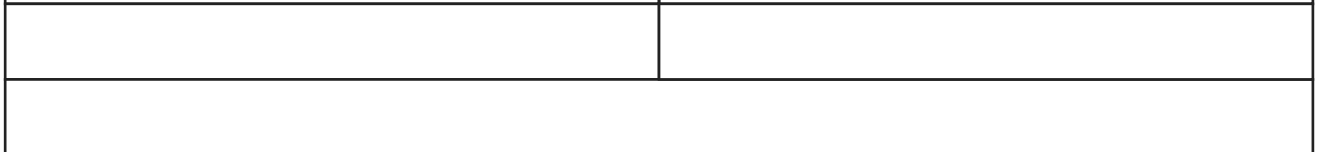
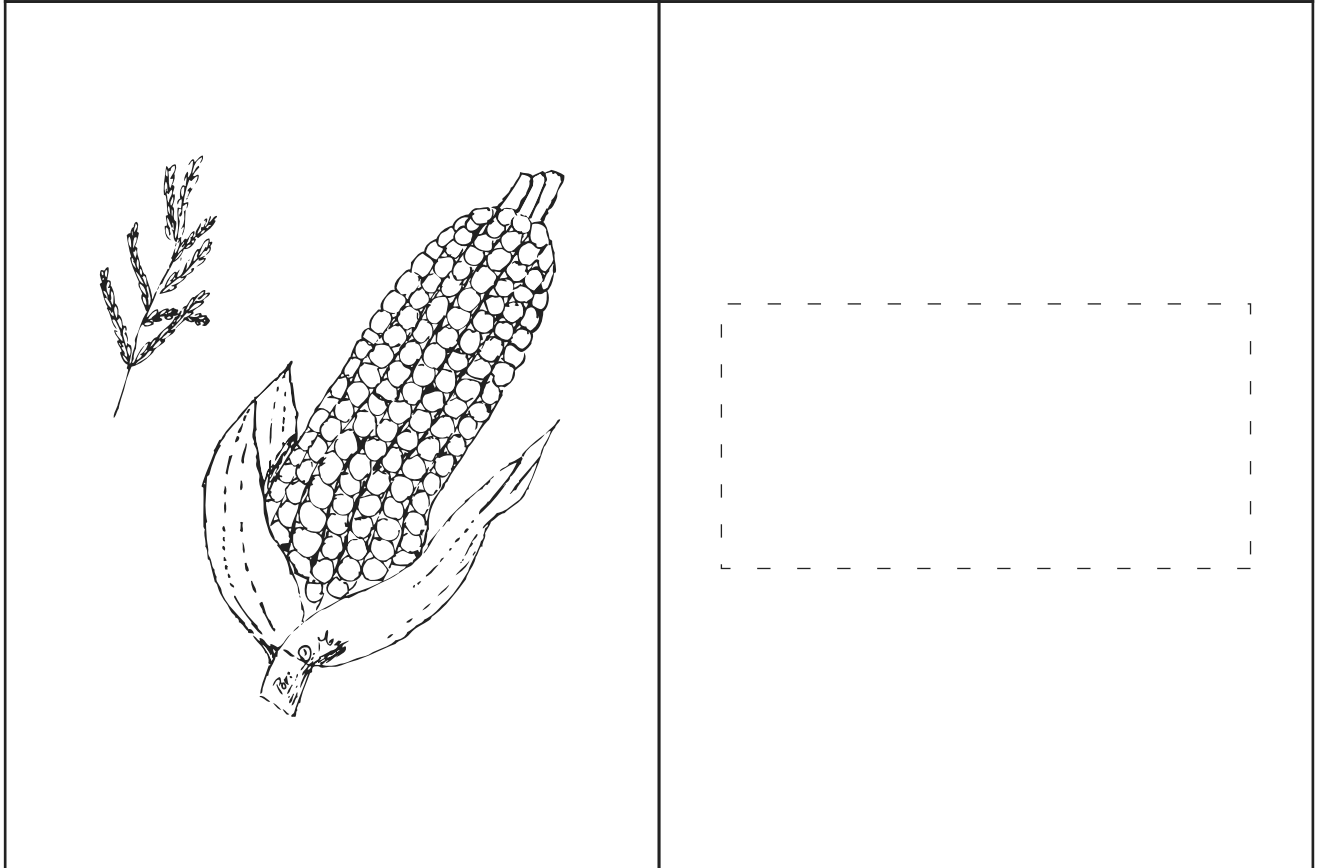
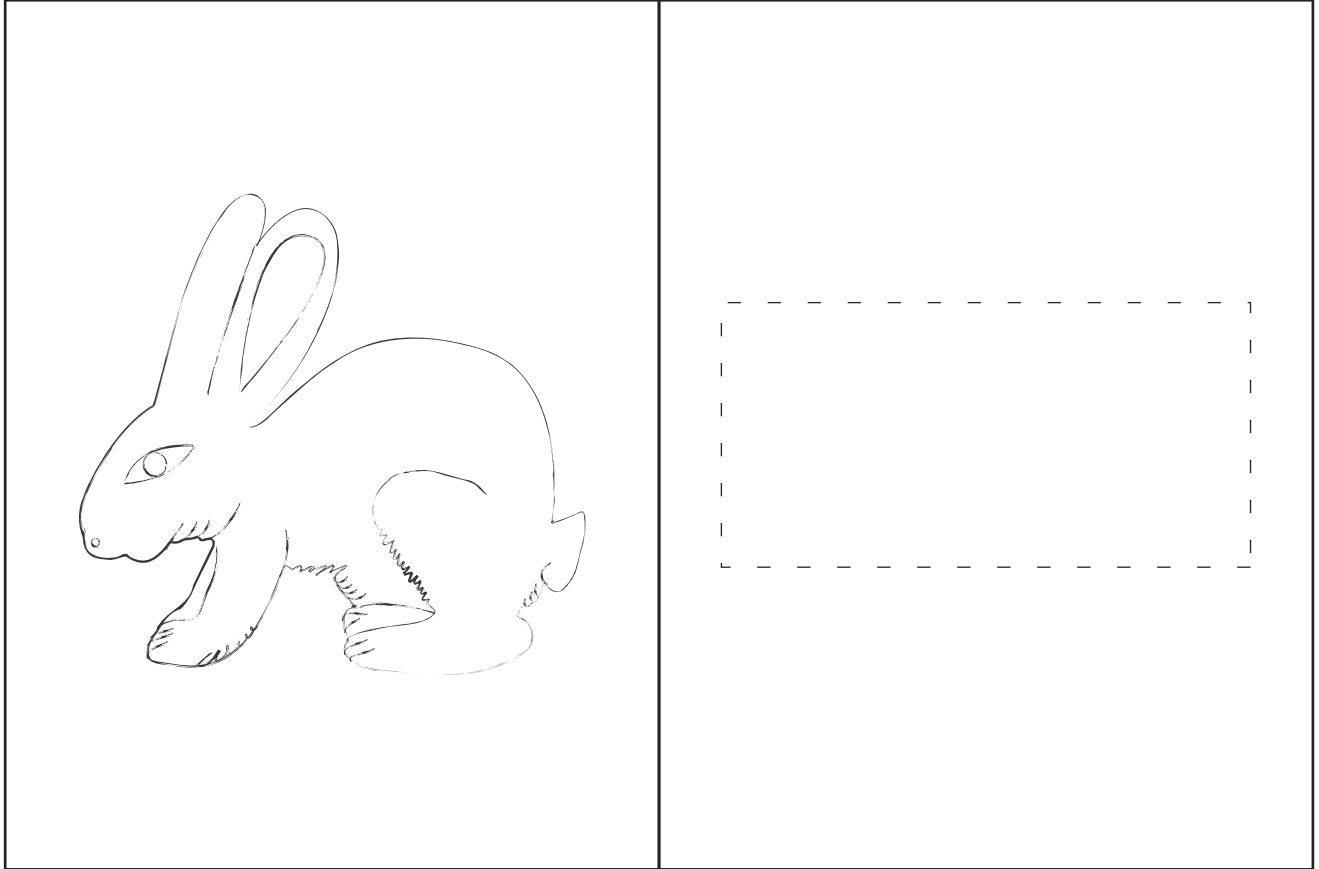

S
i
m
a

E
M
K
e
a
u
sh

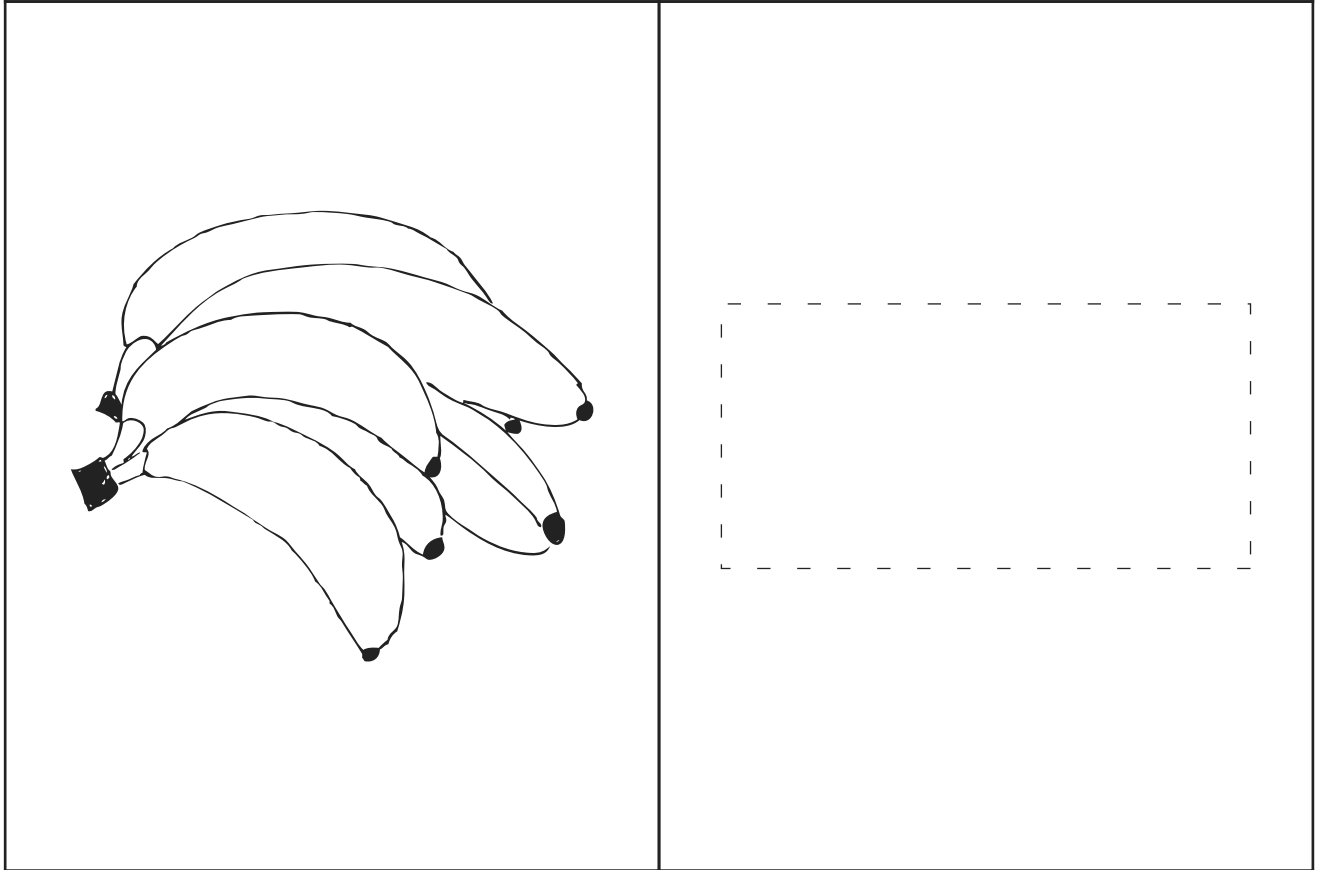
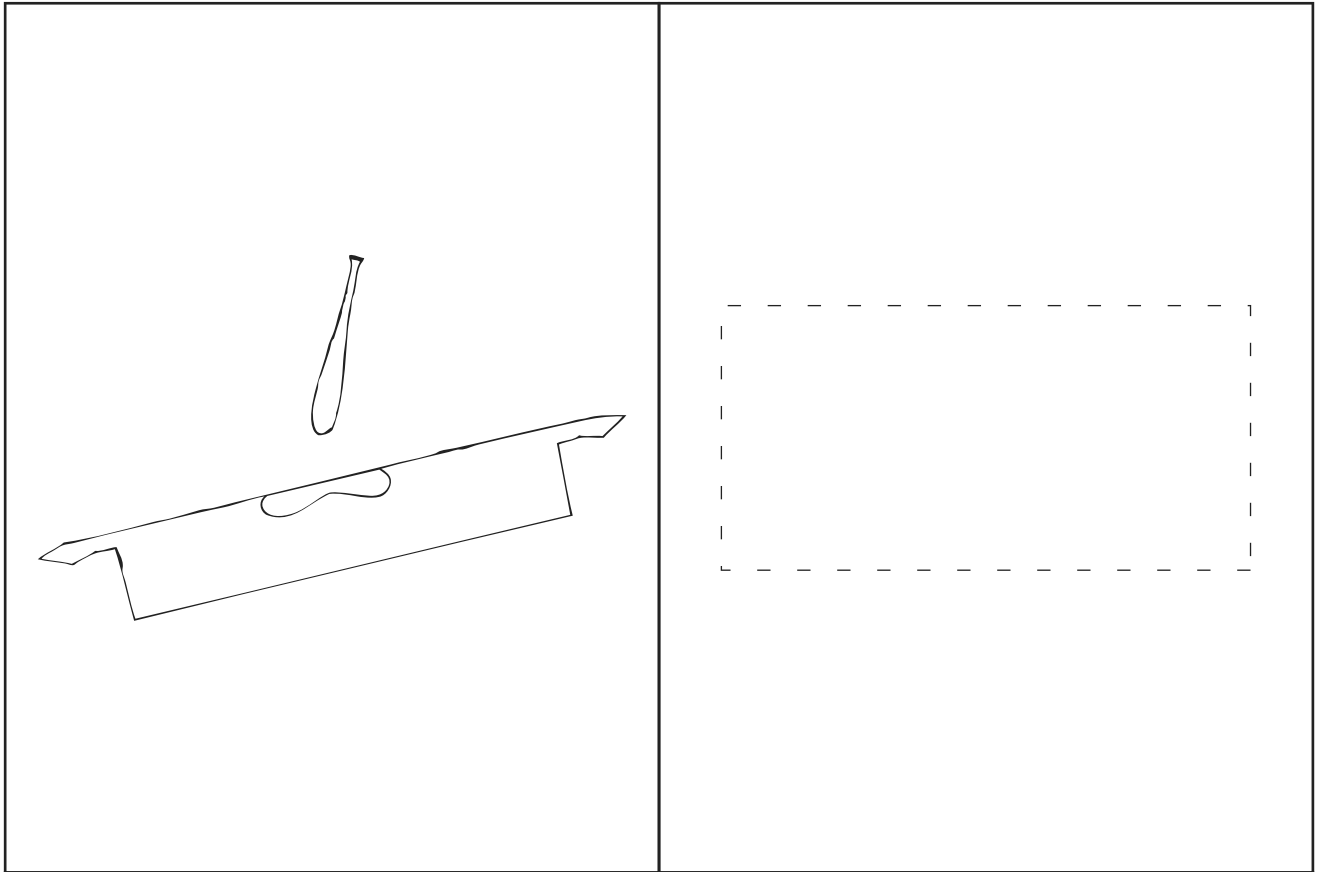

--	--

S
i
m
a

E
M
K
e
a
u
sh

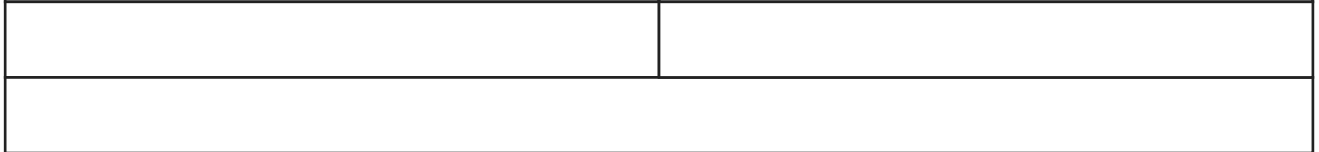
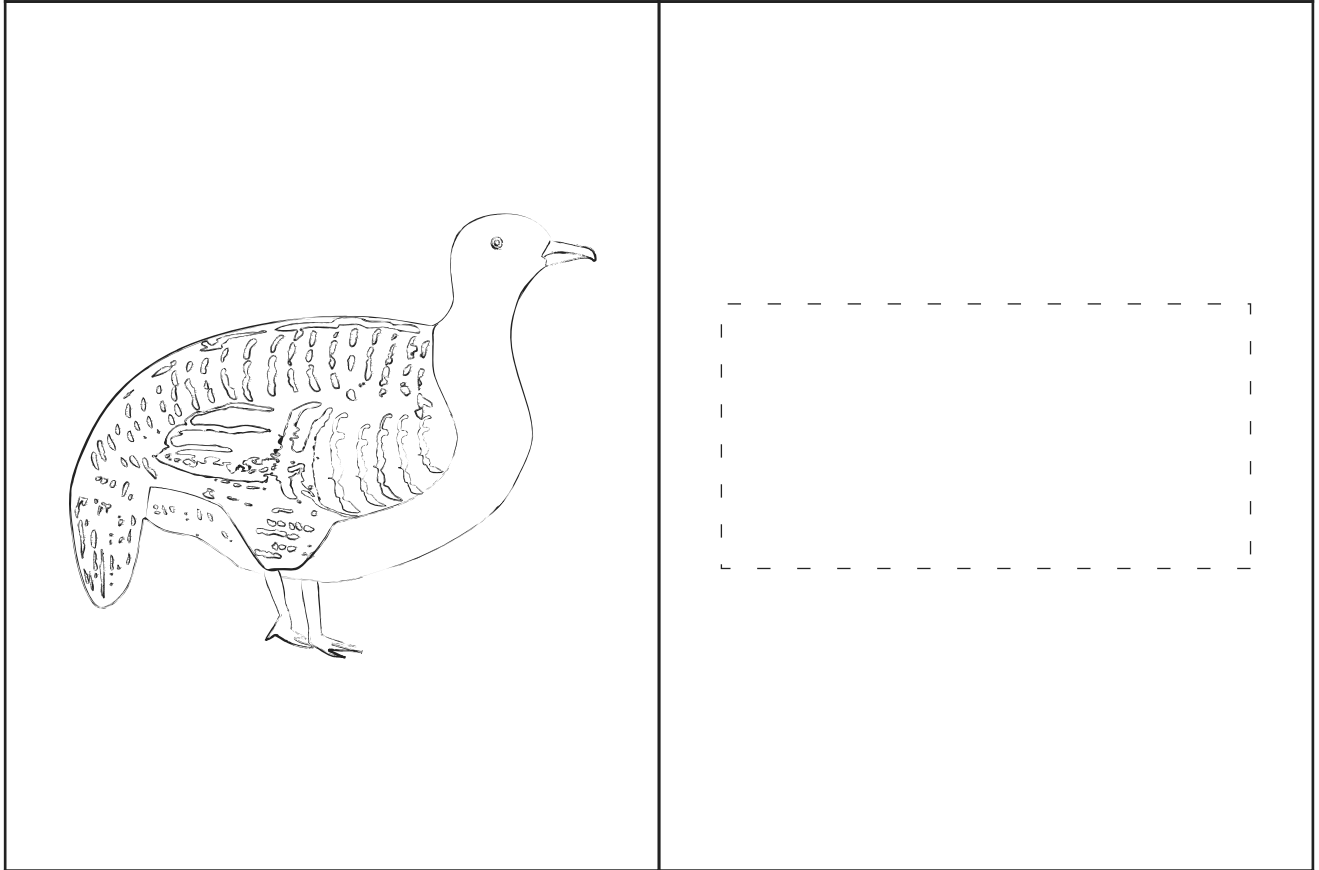
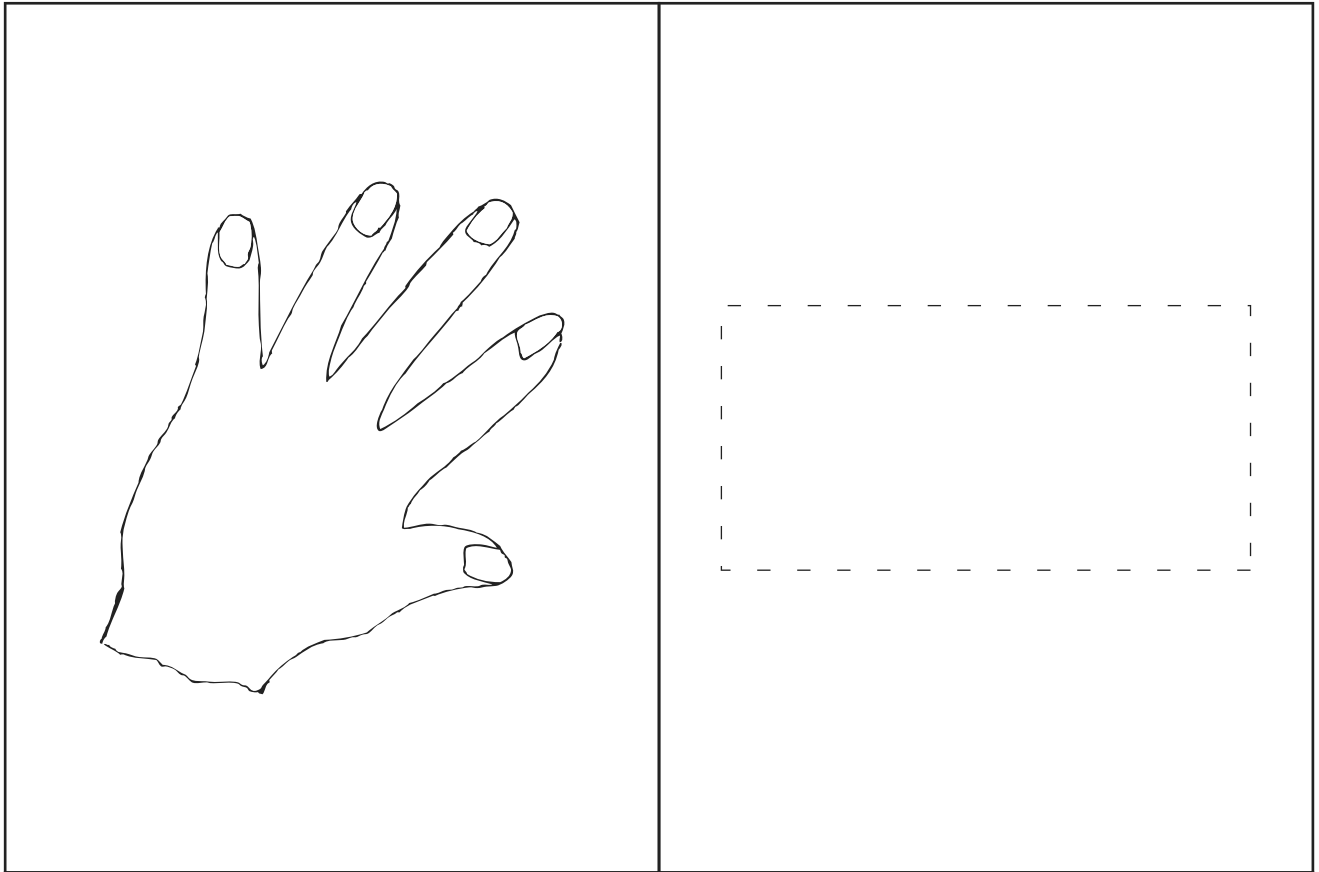

S
i
m
a

E
M
K
e
a
u
sh

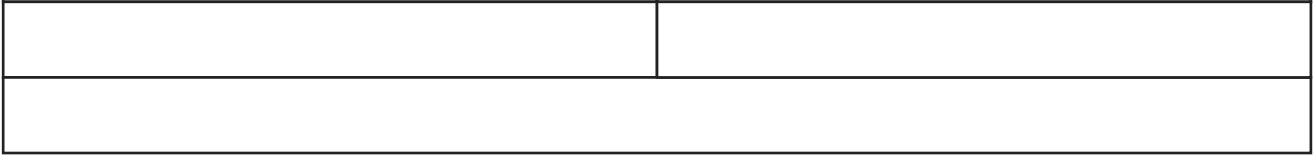
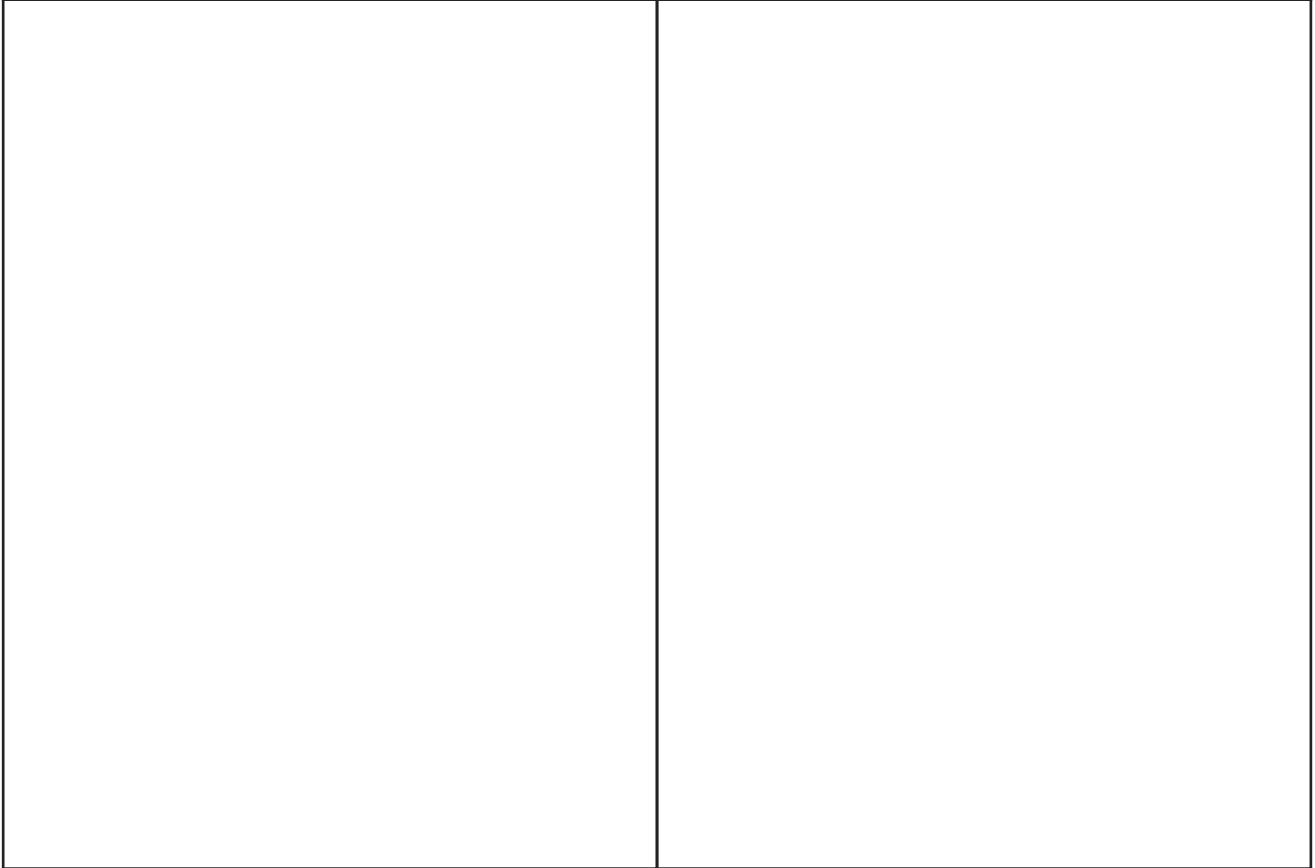
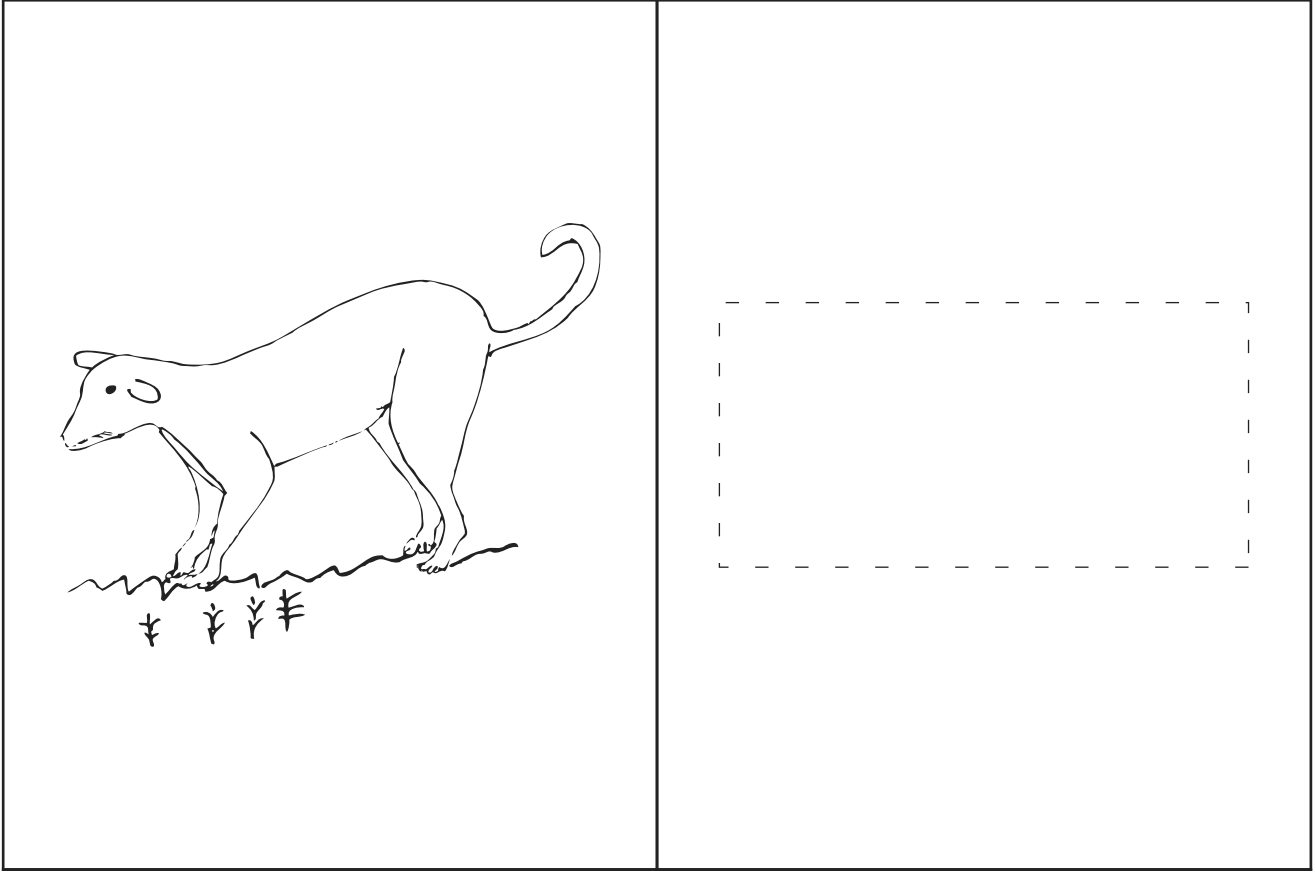

S
i
m
a

E
M
K
e
a
u
sh

sh K^m u t y sh E i S M^a y K s M





atash



chuwi



etse



ipiak



japa



kawau

E

M

Ke
a

u

sh

S

i

m

a

K^m
shu t
y

sh

E

i S

M^a
y

K

s

M





mama



nanki



pama



ramian



sawa



shaá

E

M

K e
a

u

sh

S

i

m

a

K m
sh

u t

sh

E

i S

M a

y

K

s

M



tuntui

tsamau

uwej

waa

yawa

E

M

K_e

a

u

sh

S

i

m

a

K_m

sh

u

t

y

sh

E

i

S

M

a

y

K

s

M

