

Ñukanchik Kawsay 1

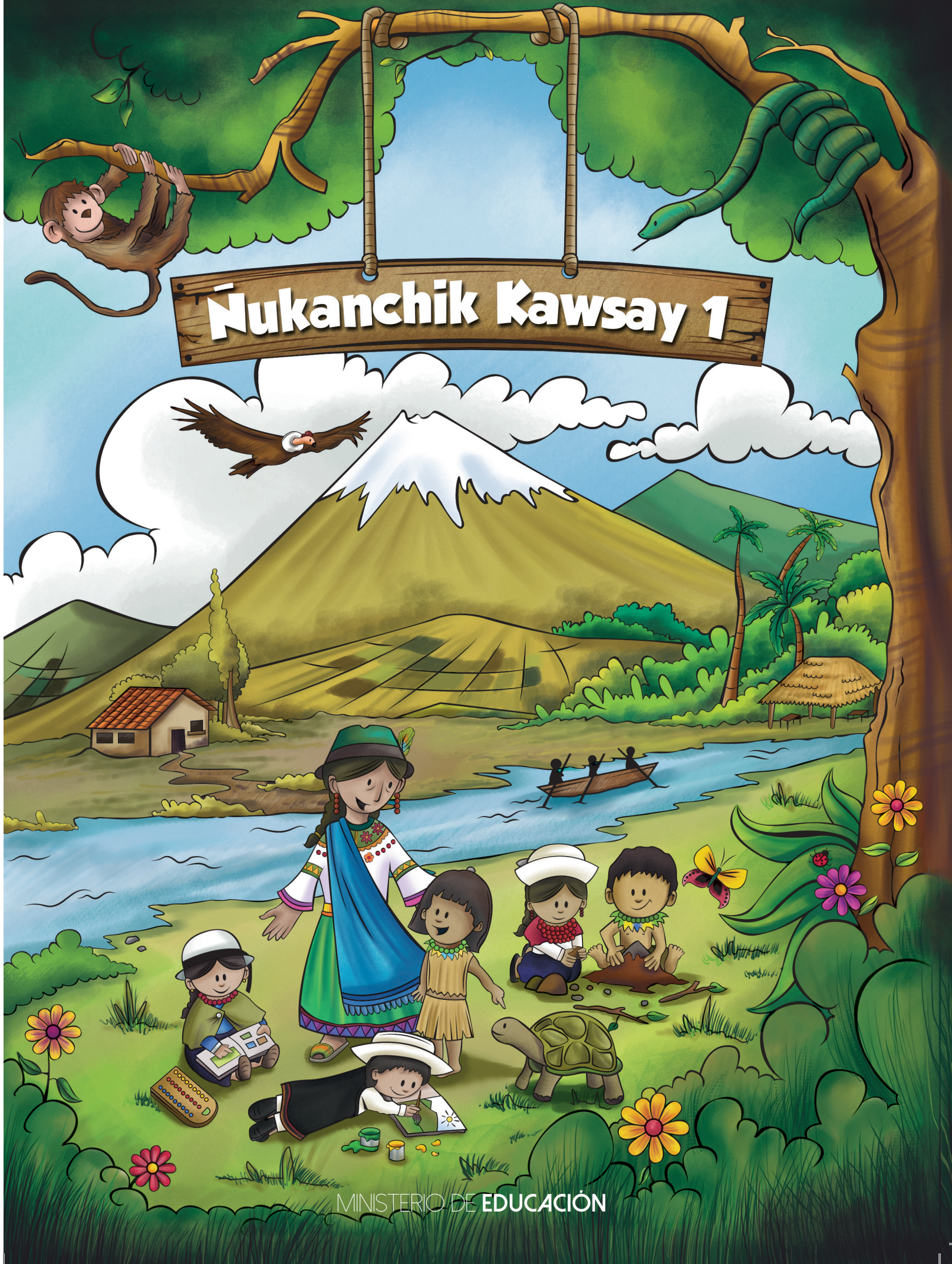

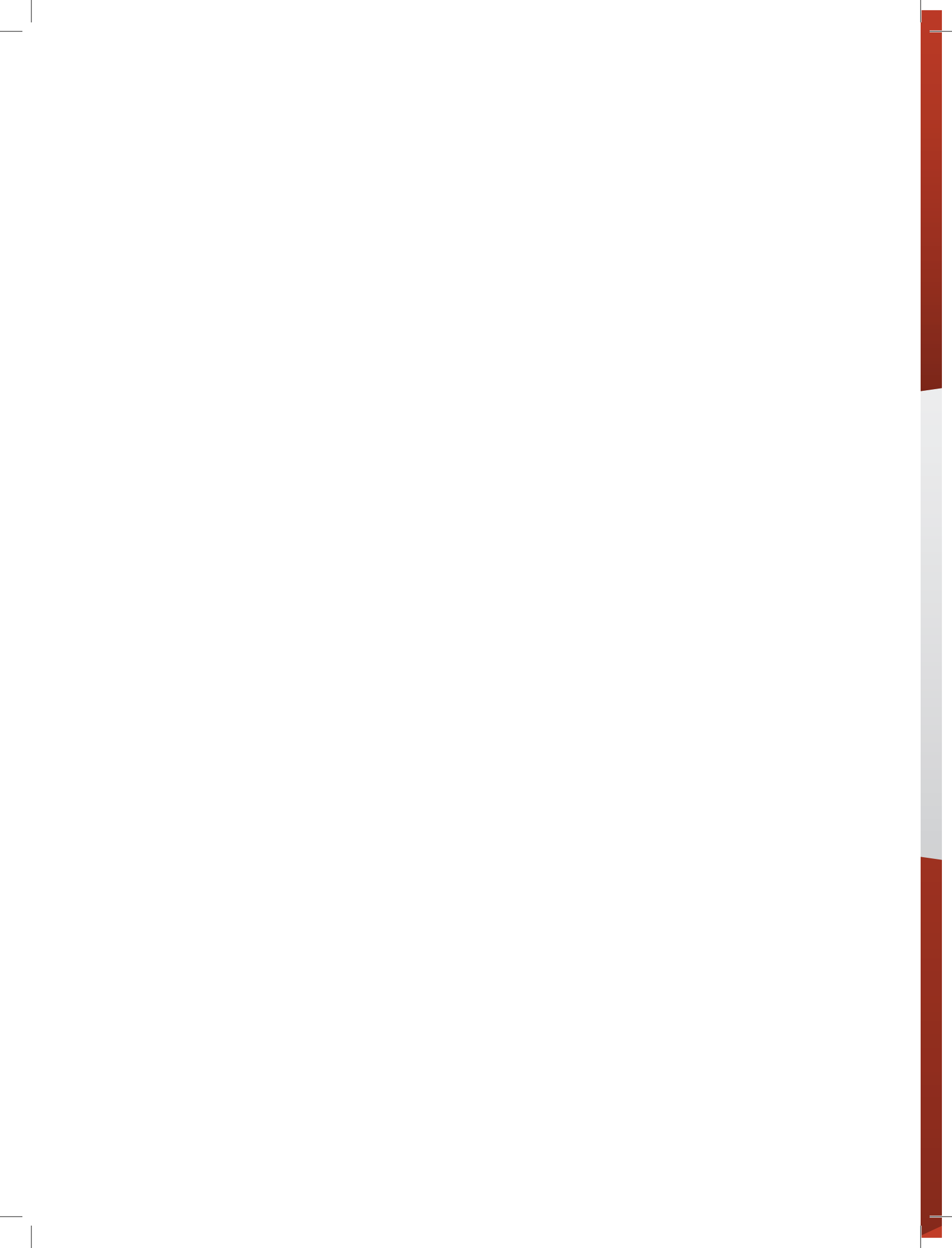

11

TANTACHISHKA YACHAY



Pachamamapa Wawakunami Kanchik

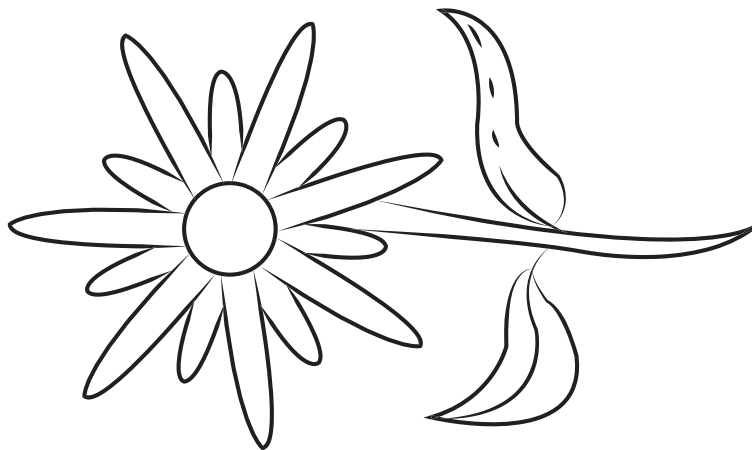
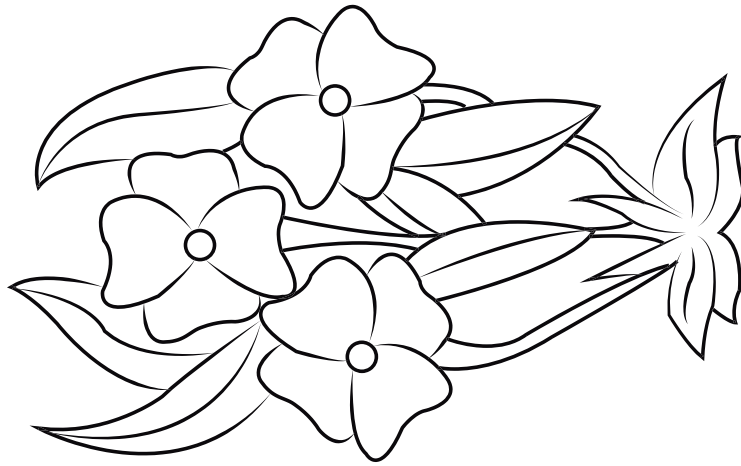

Shuti:

1 Panka

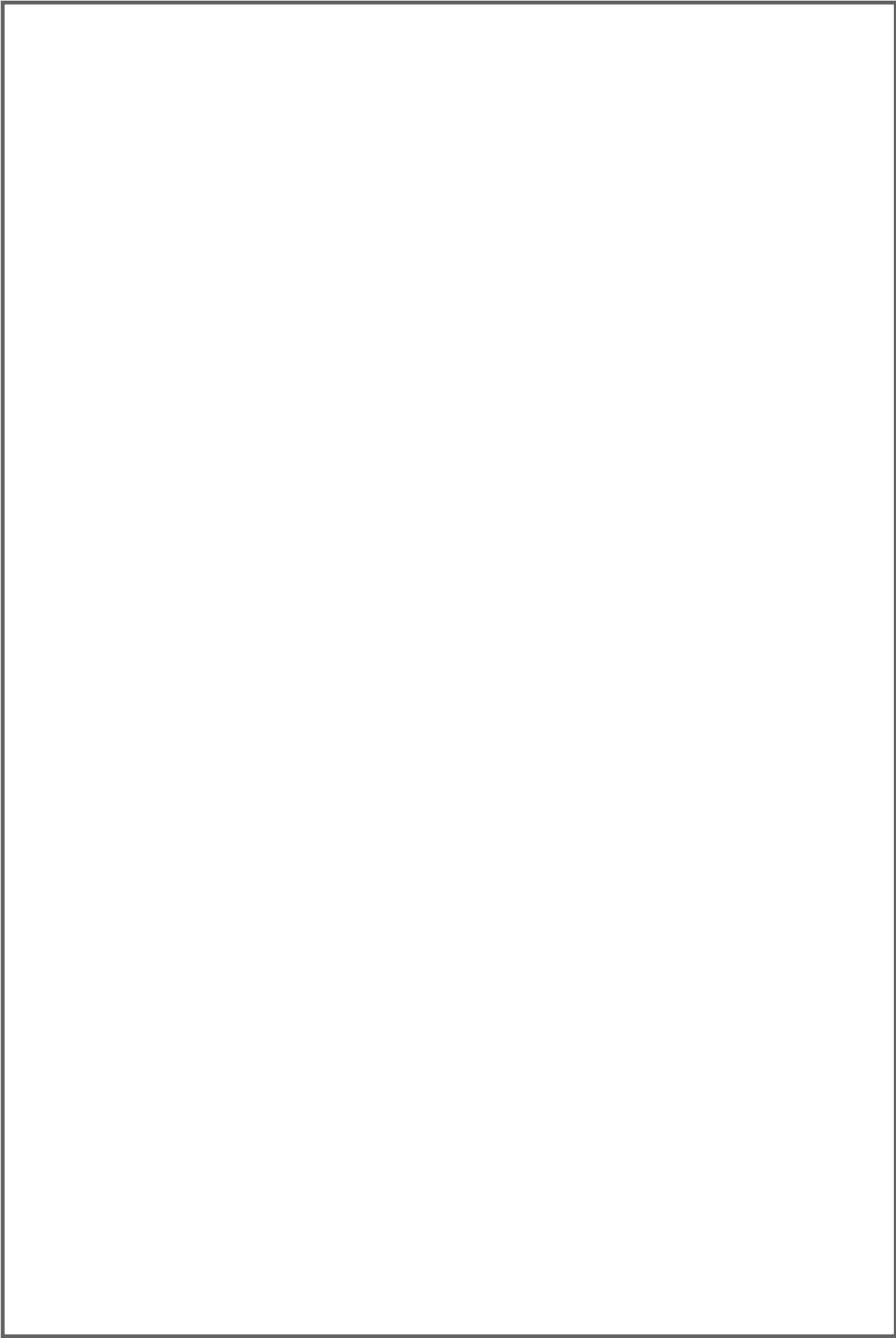

Shuti:

2 Panka



Shuti:

3 Panka

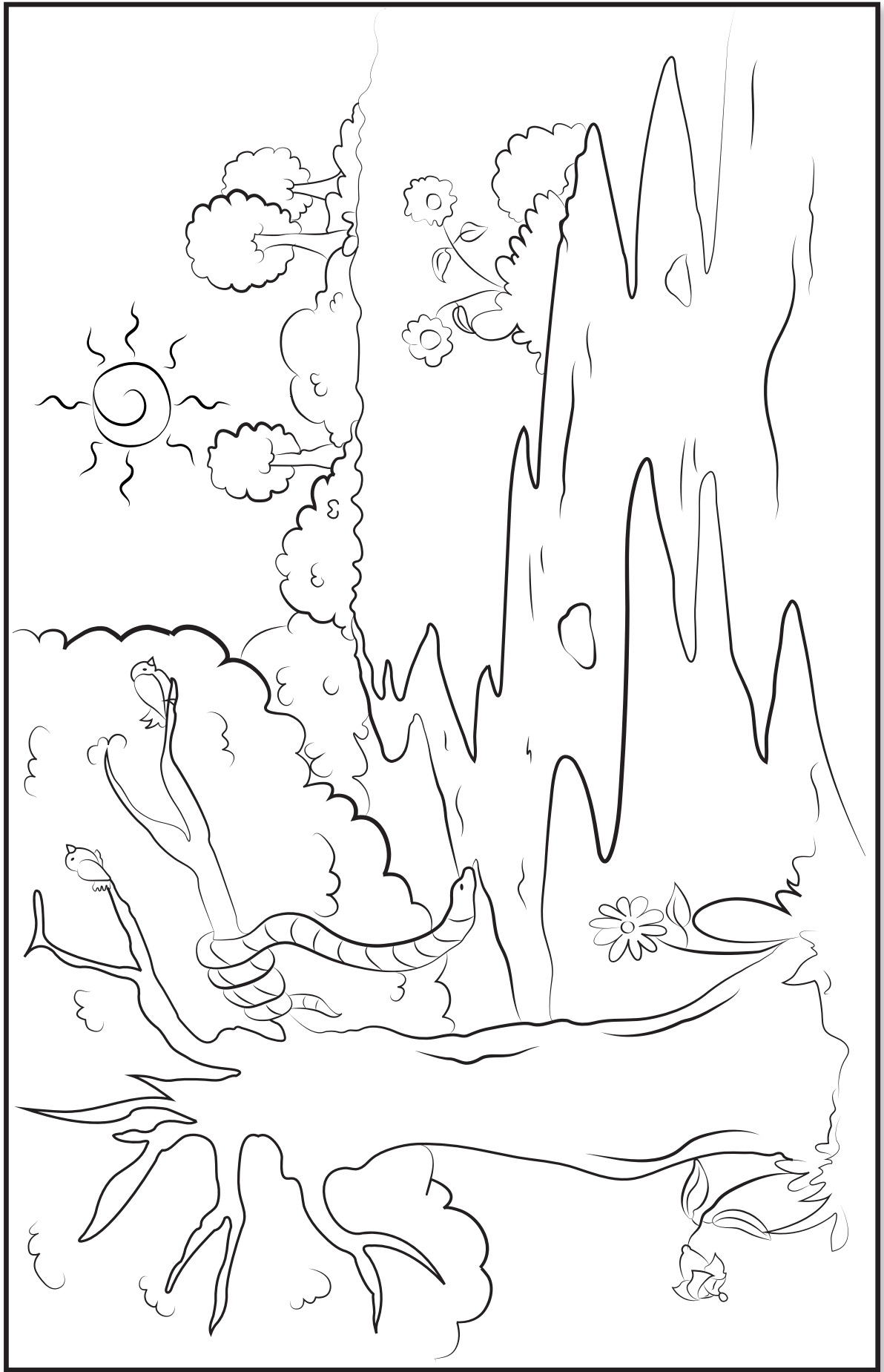

Shuti:

4 Panka

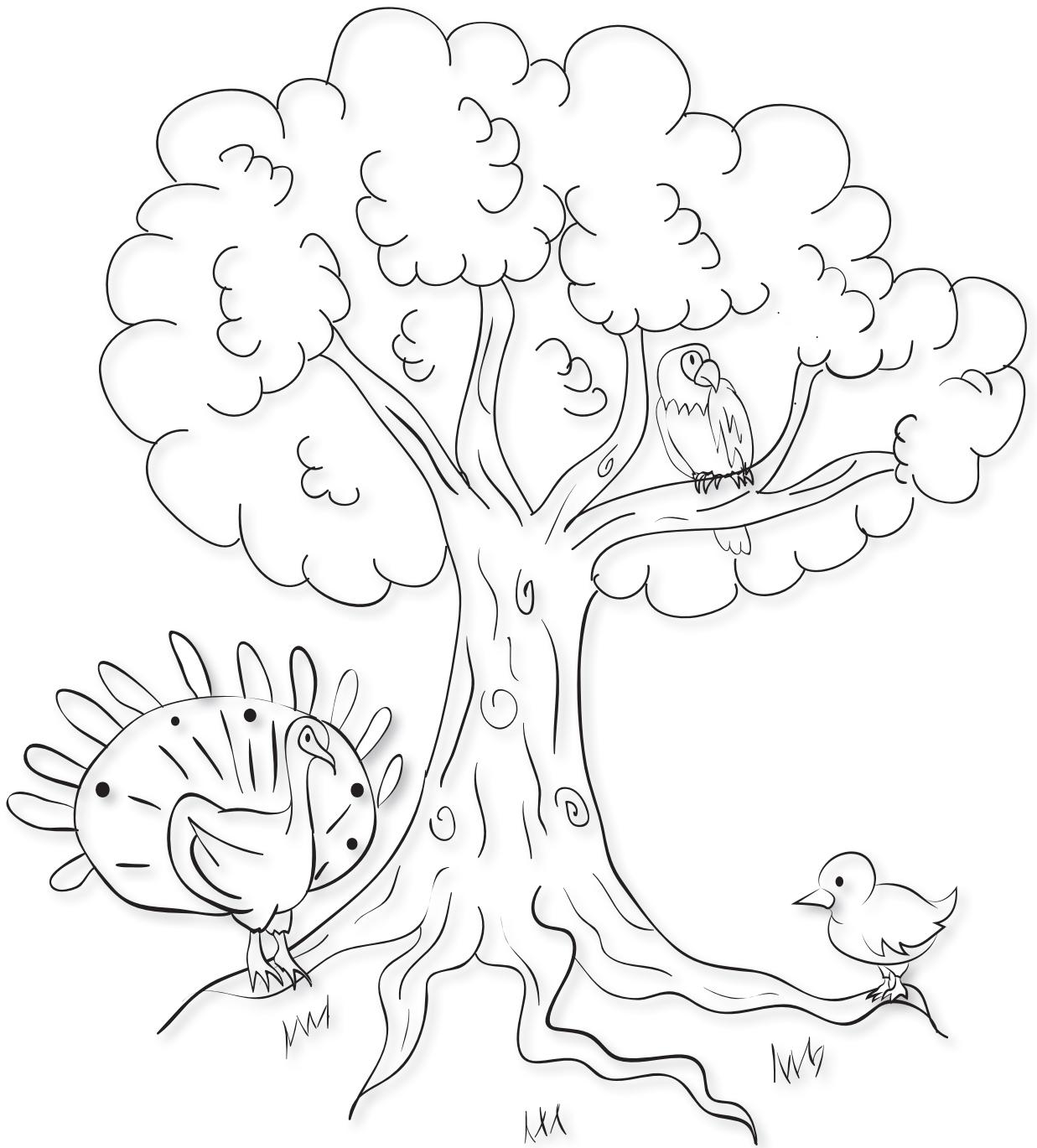

Shuti:

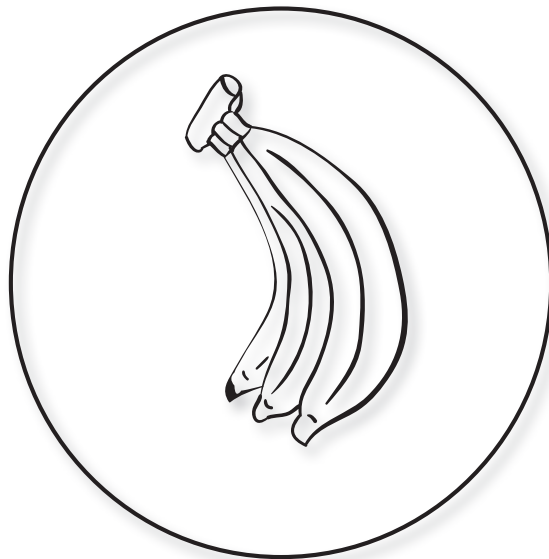
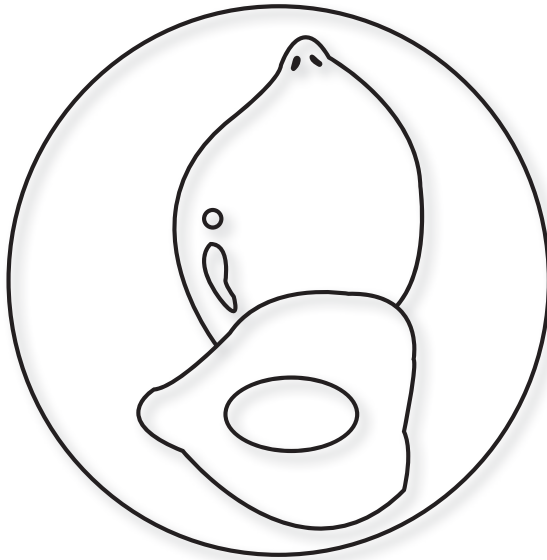
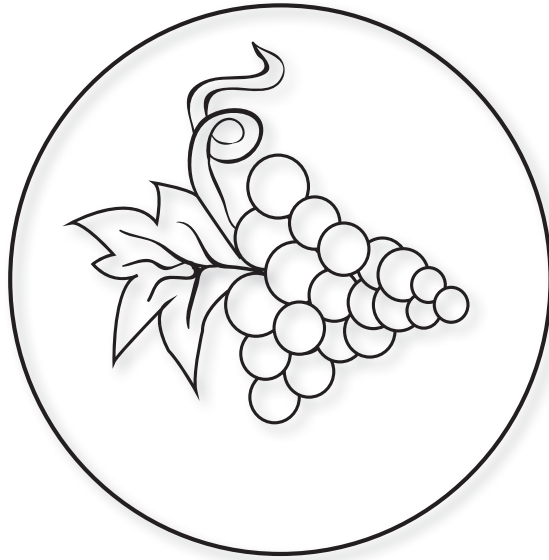

Shuti:

A horizontal rectangular box with a dashed line inside, intended for writing the answer to the question.

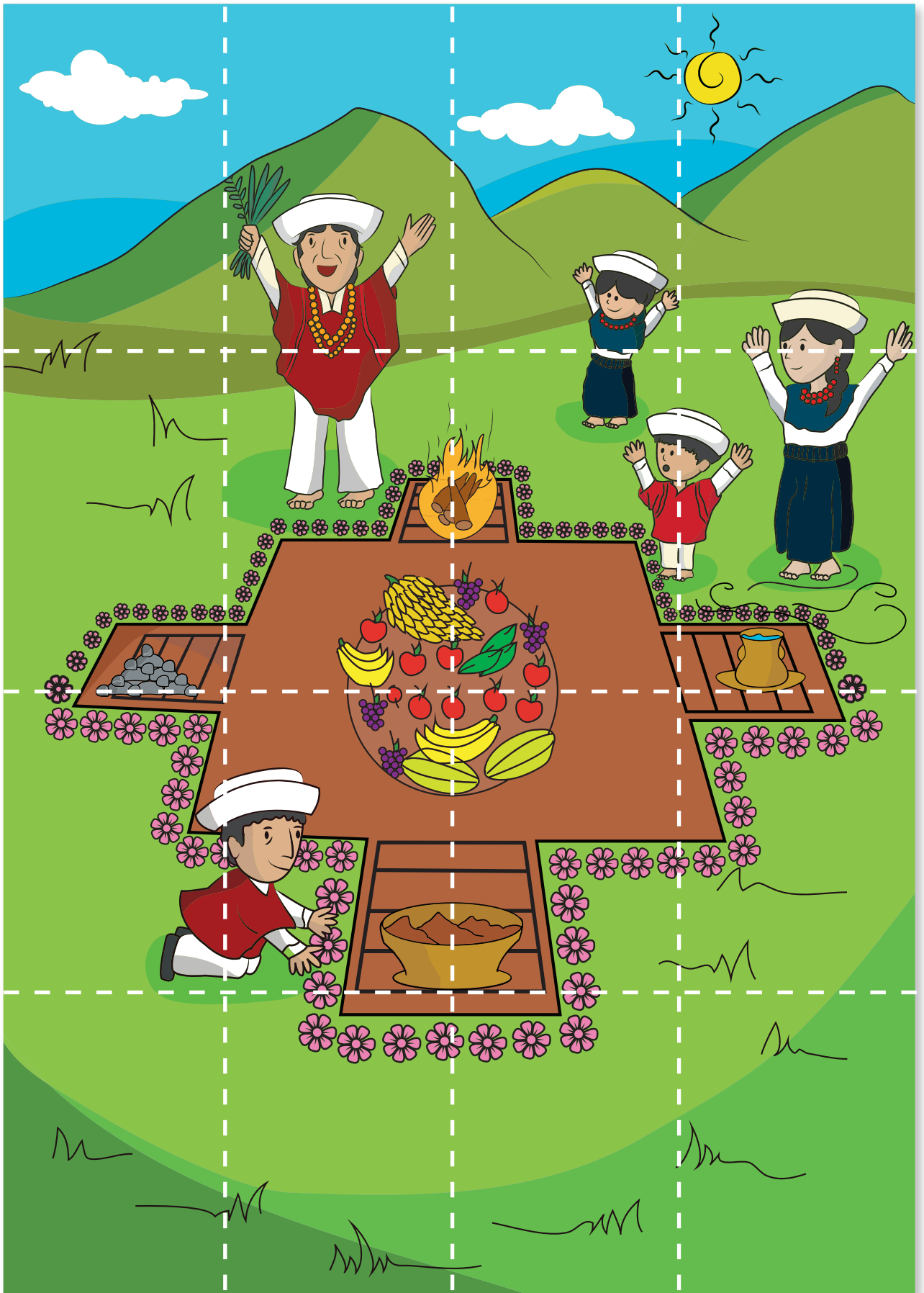

Shuti:





Shuti:

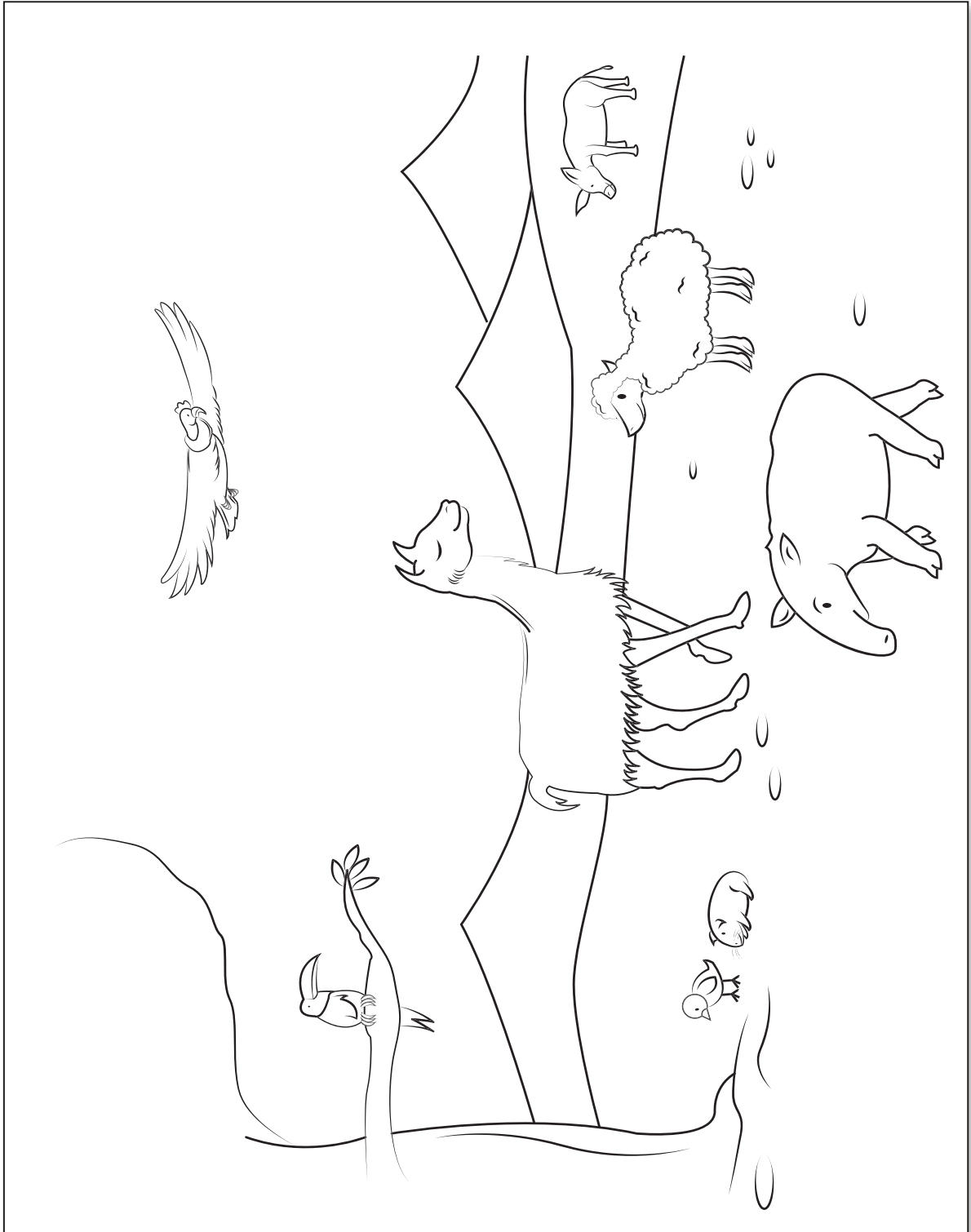

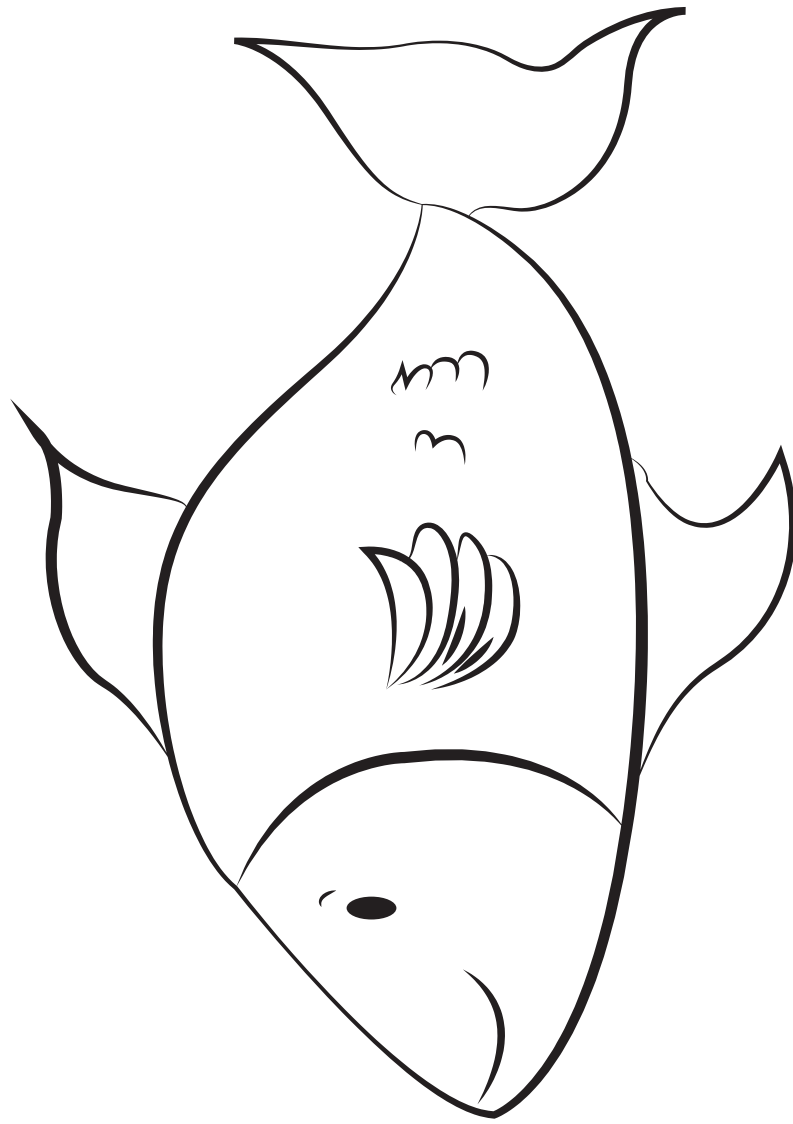

Shuti:

Blank space for writing the answer.



Shuti:

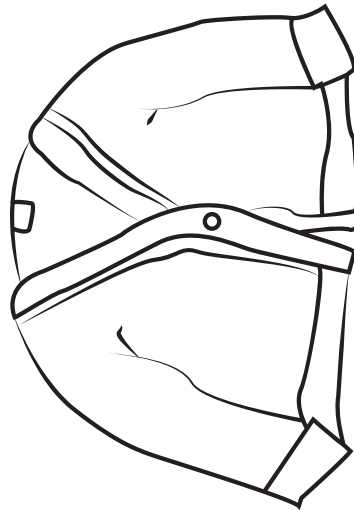
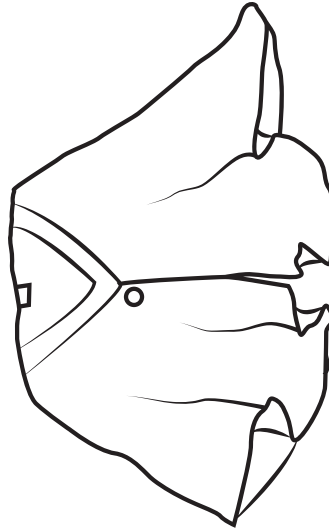
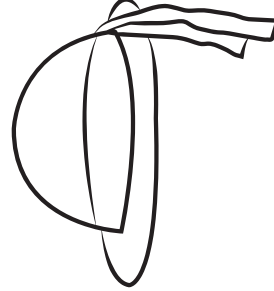
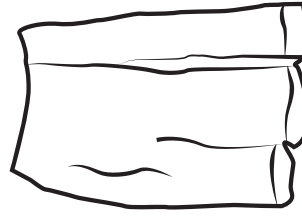
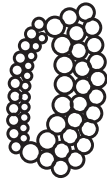

12 TANTACHISHKA YACHAY



Ñukanchik Ayllu

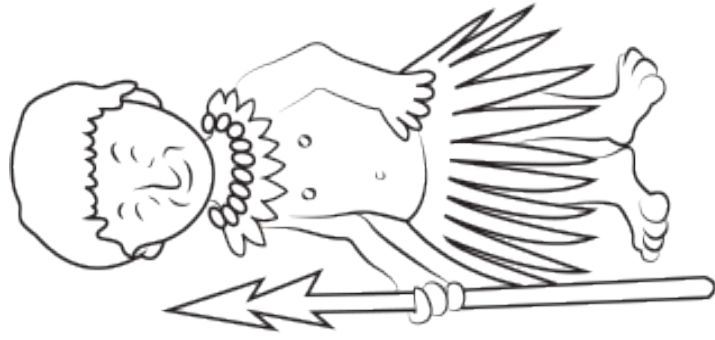

Shuti:

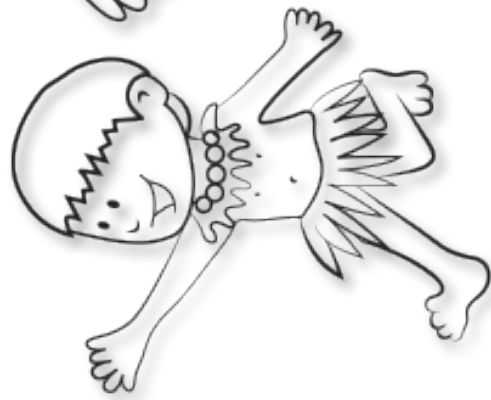
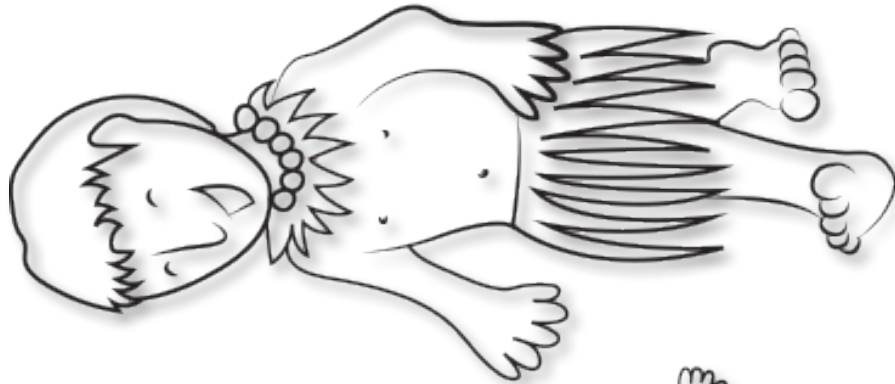

Shuti:

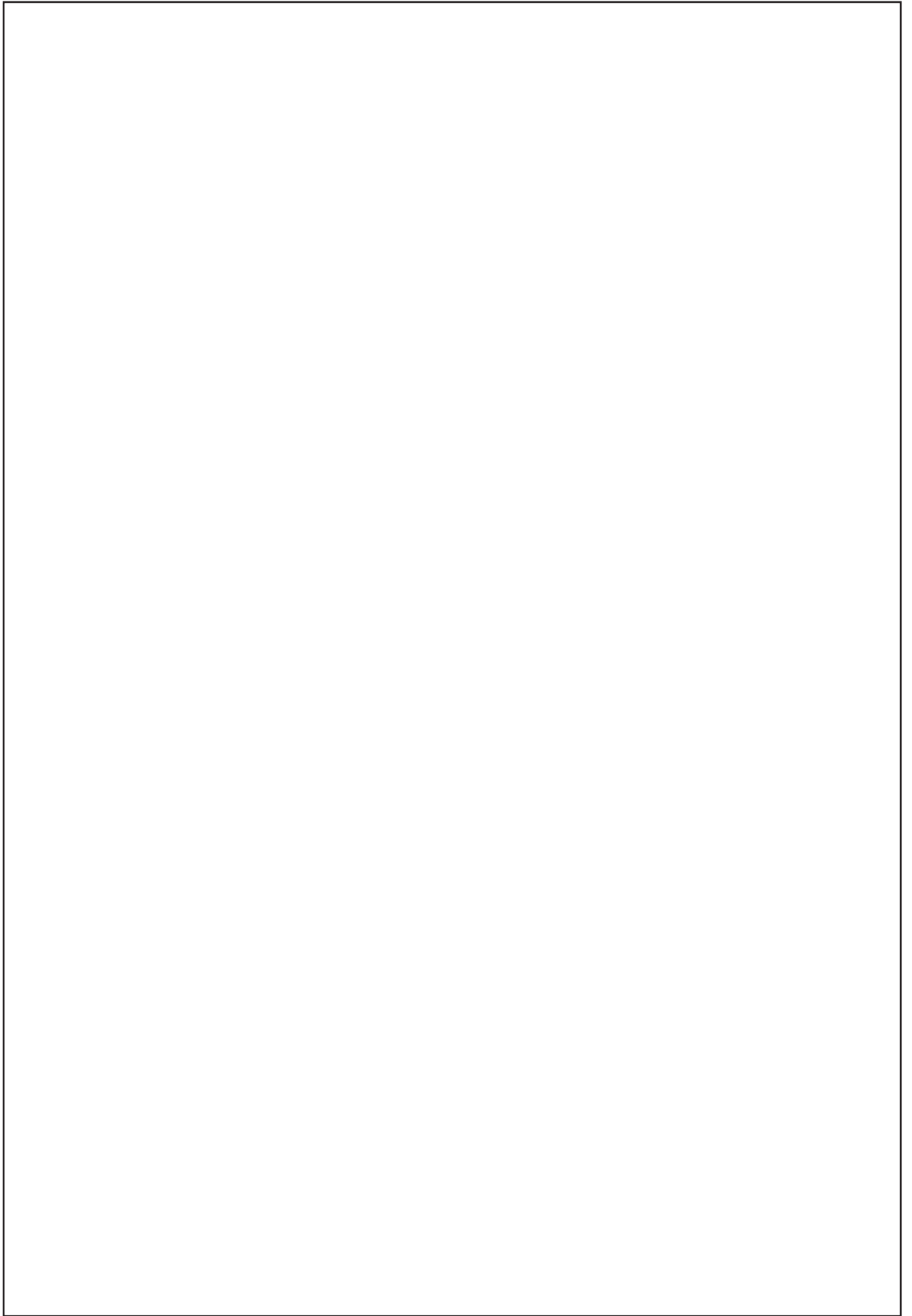

Shuti:

13 Panka

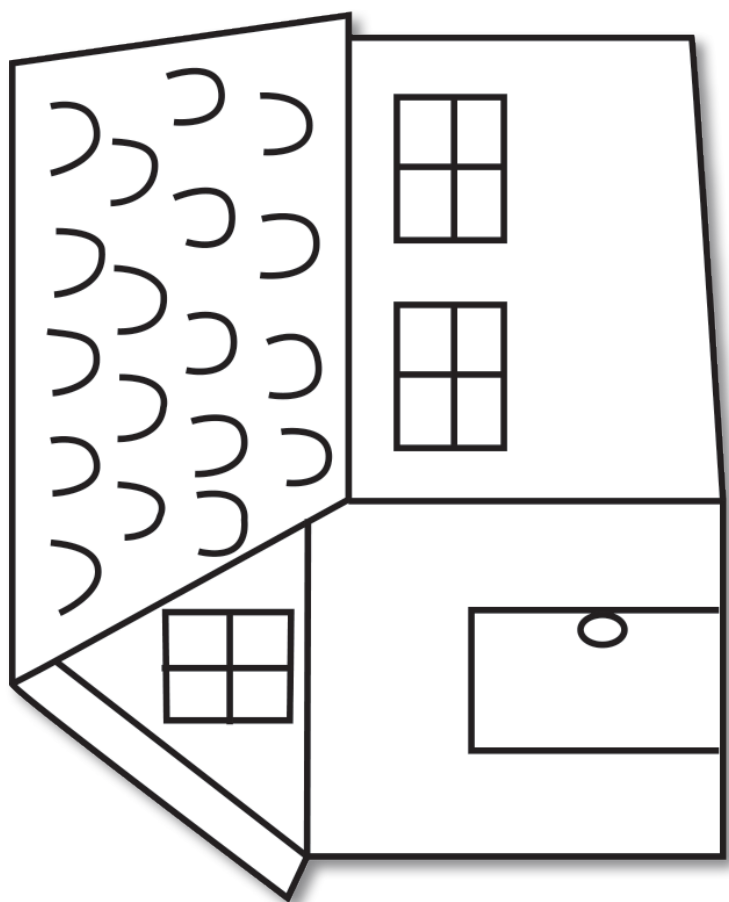
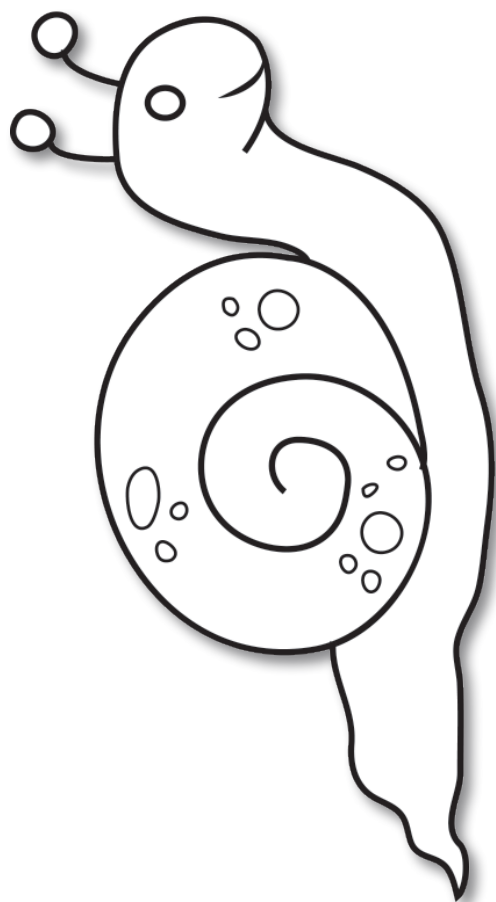
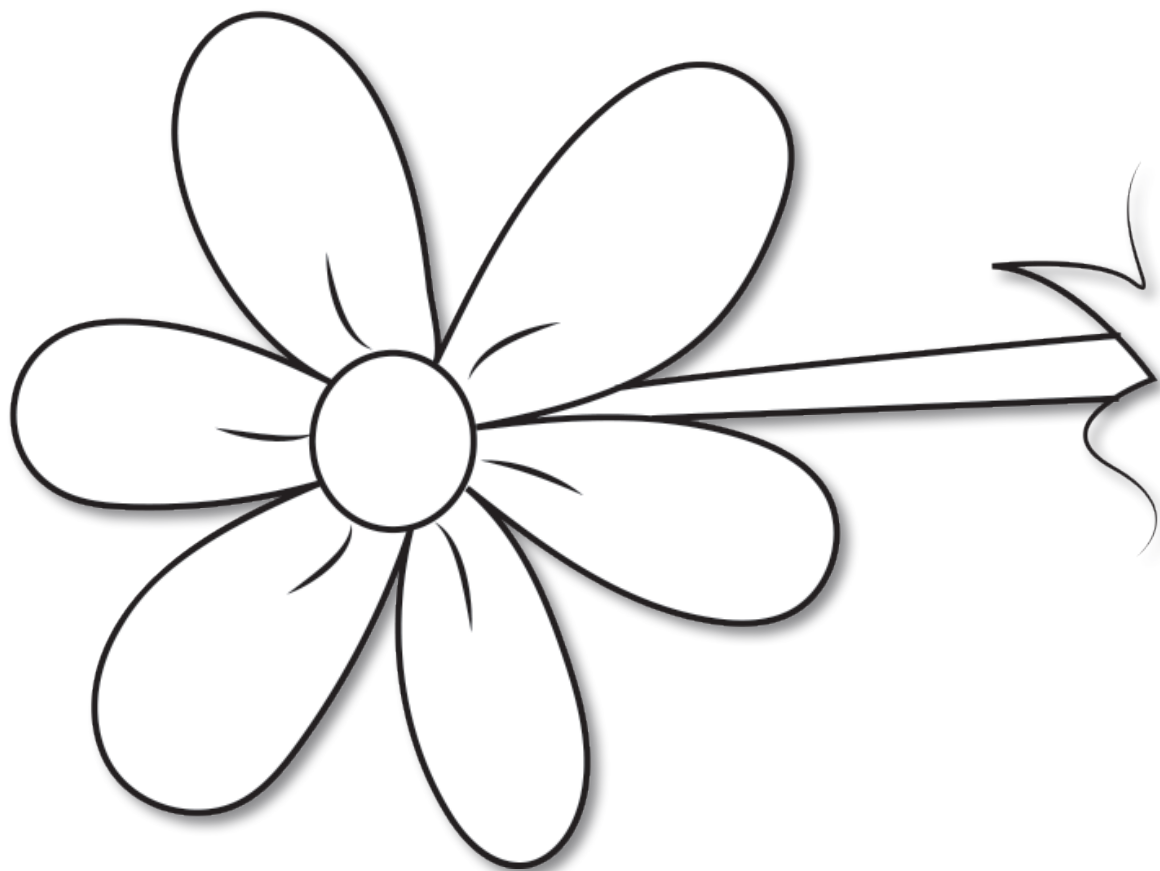

Shuti:

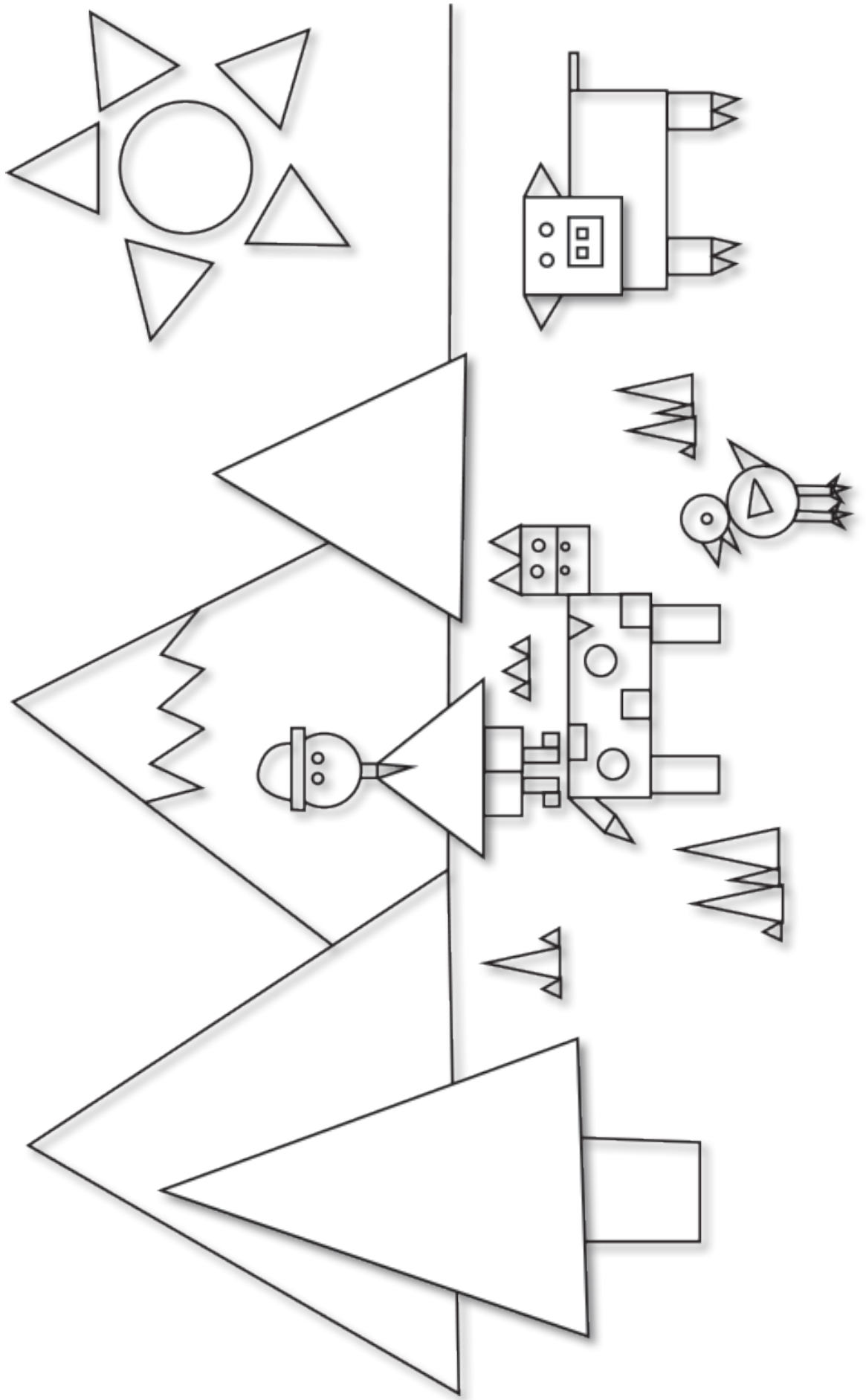

Shuti:

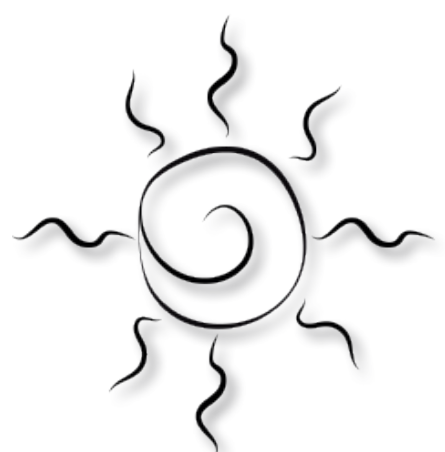
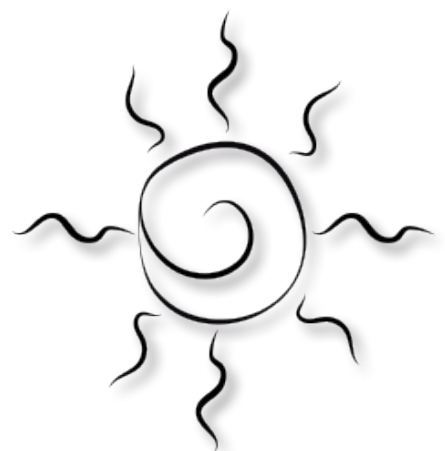
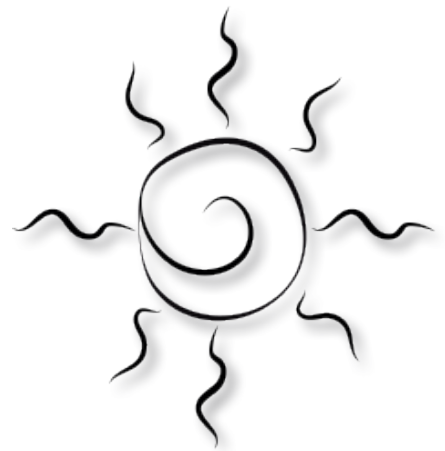
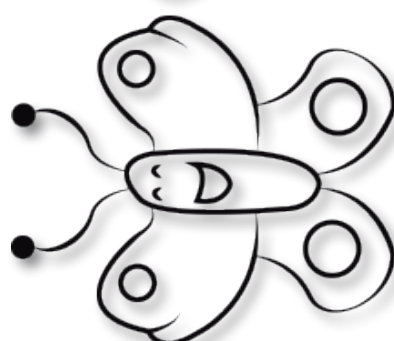
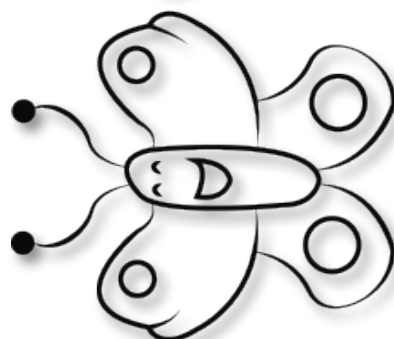
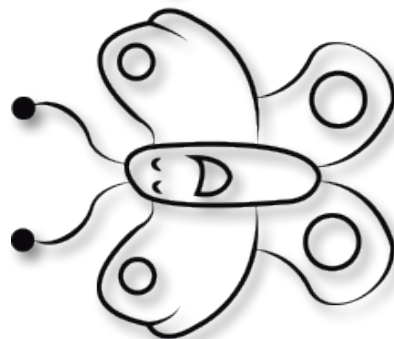
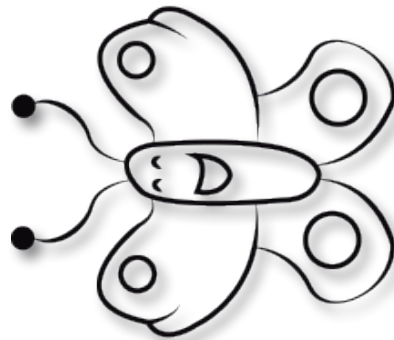
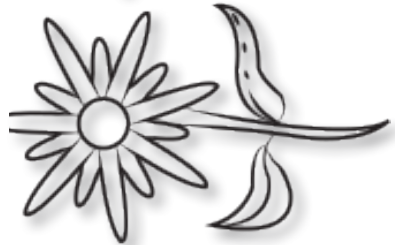
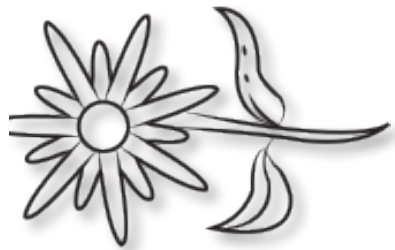

Shuti:



Shuti:

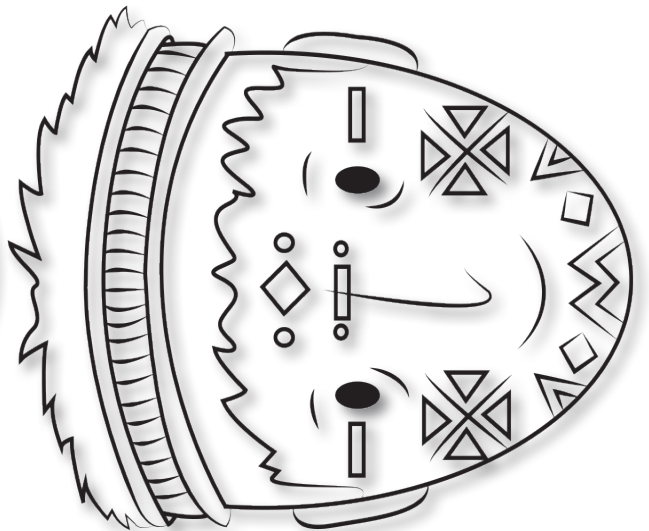
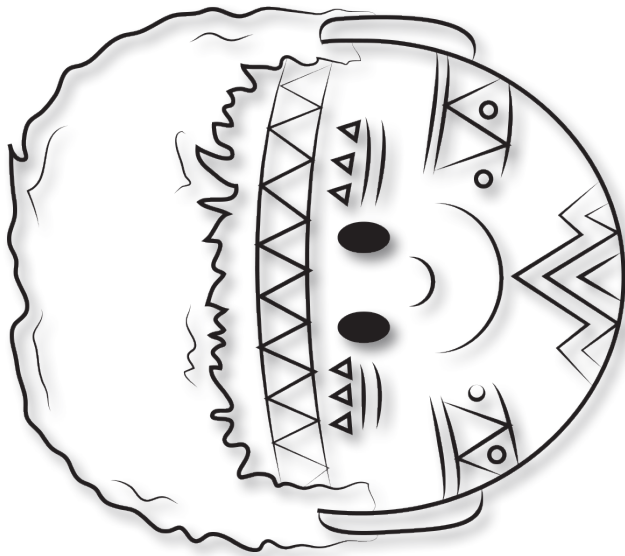
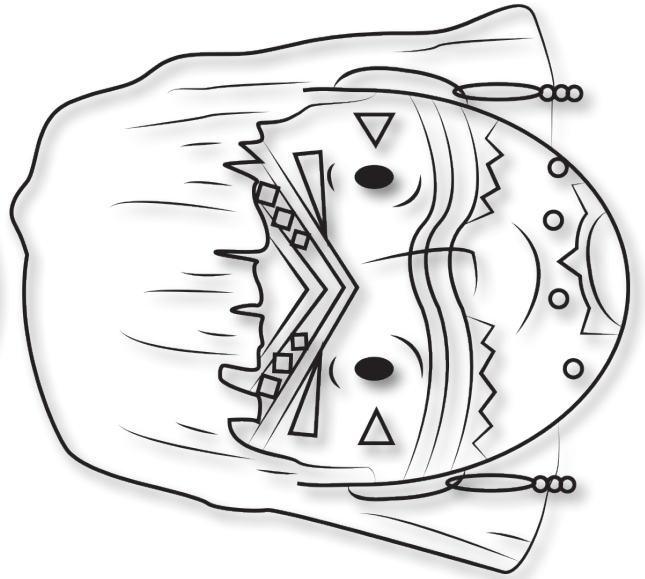
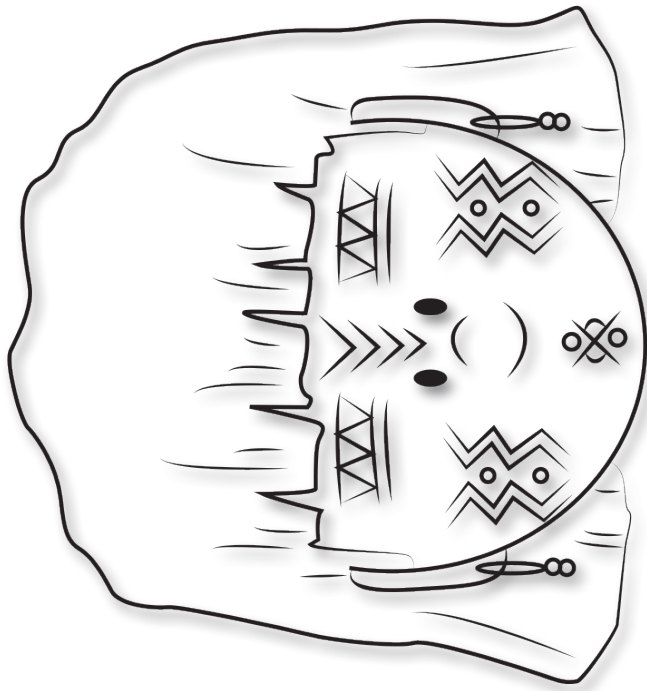

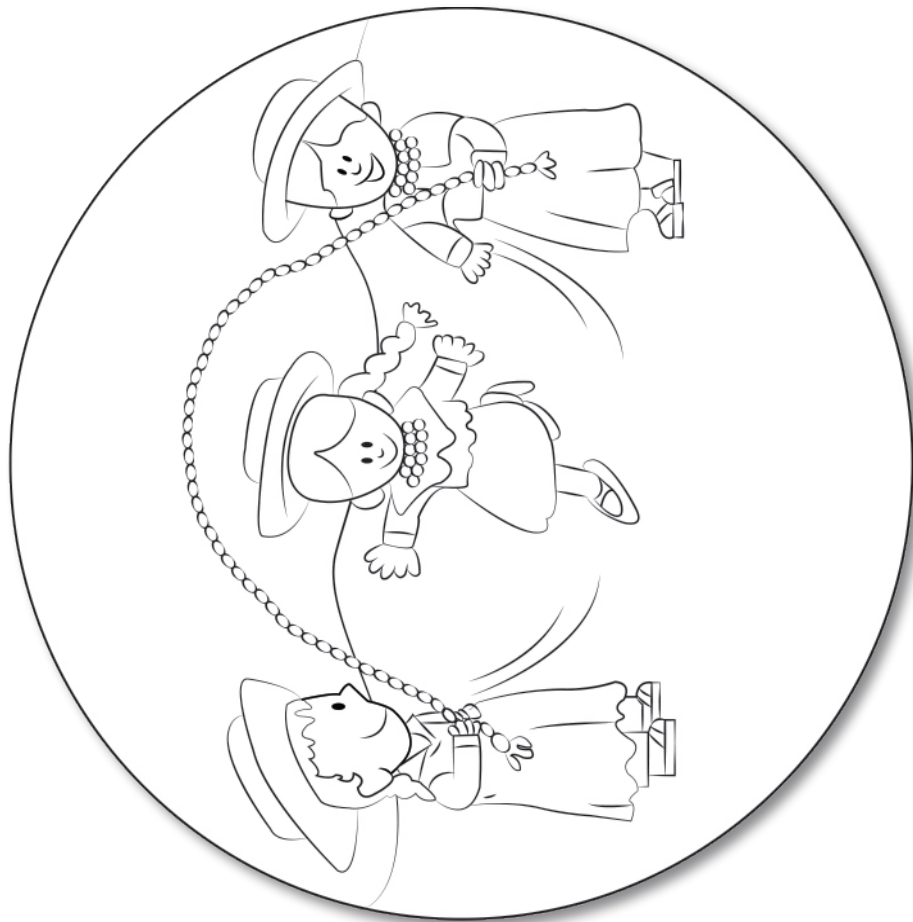
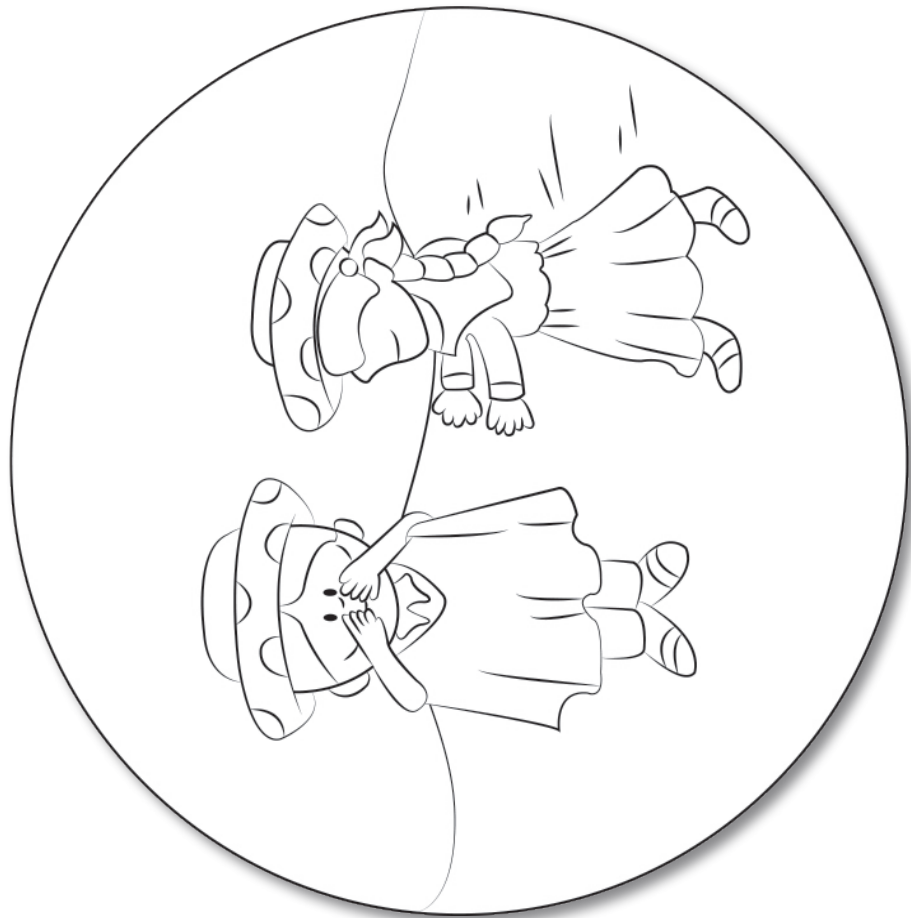

Shuti:



Shuti:

A horizontal rectangular box with a dashed line inside, intended for writing the answer to the question.

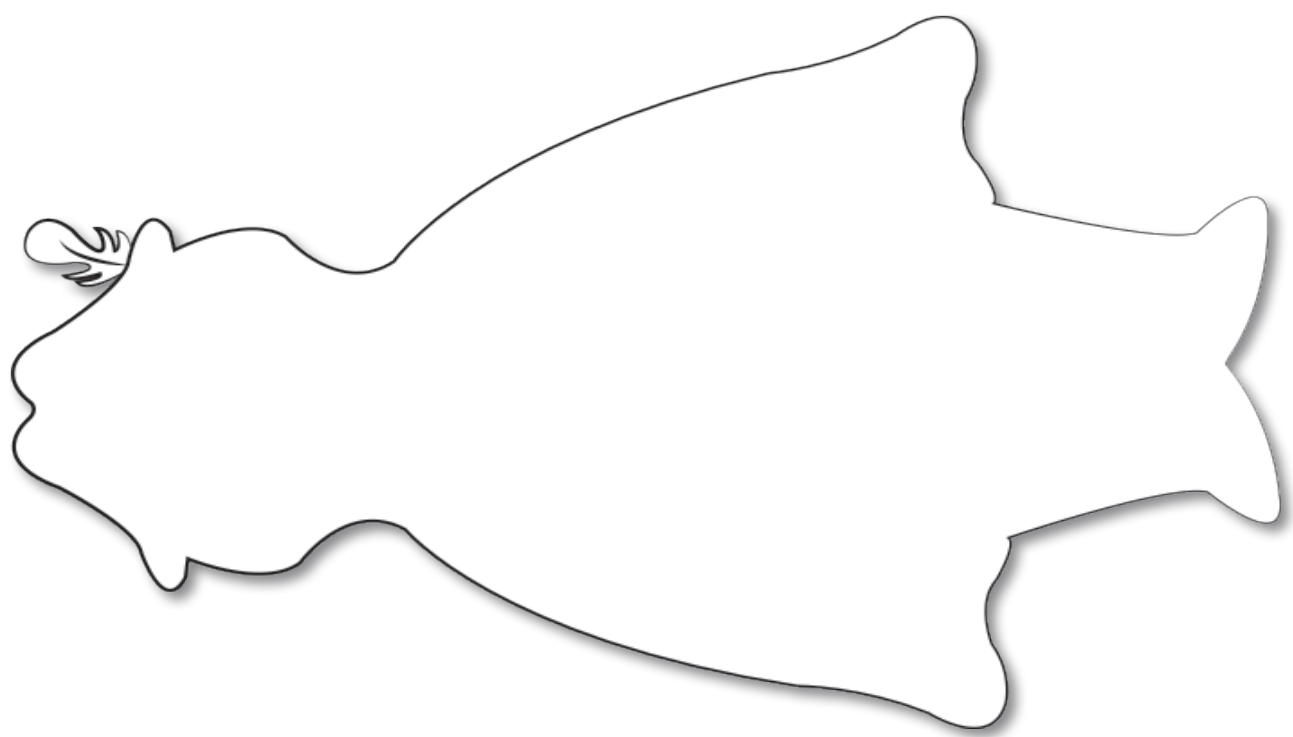
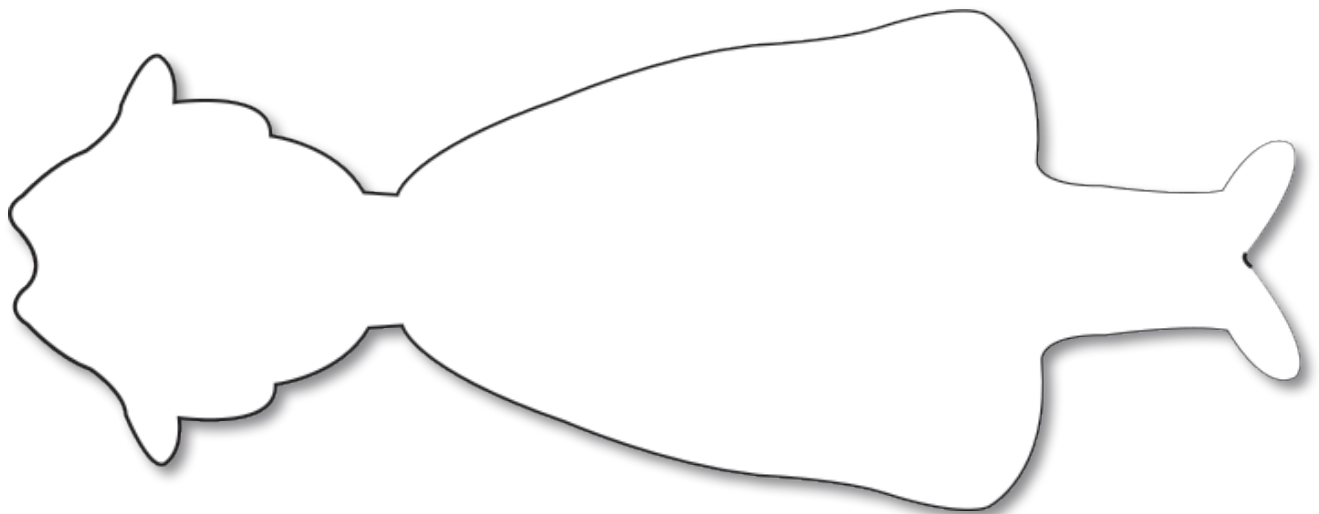

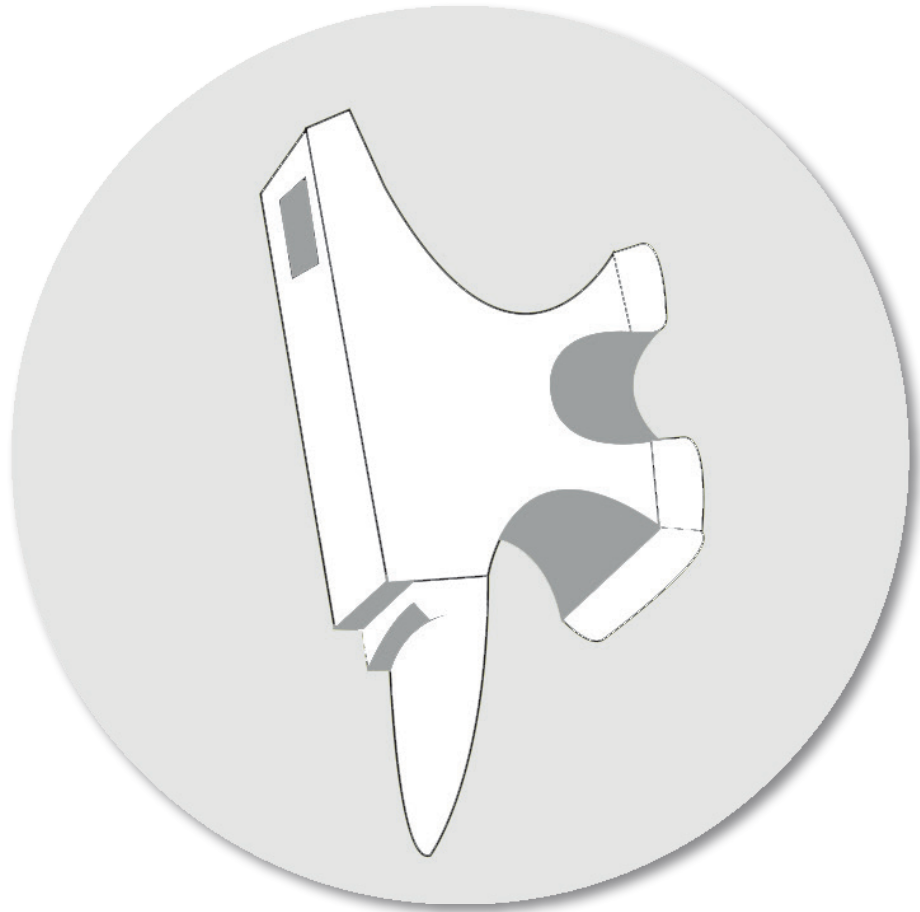

Shuti:

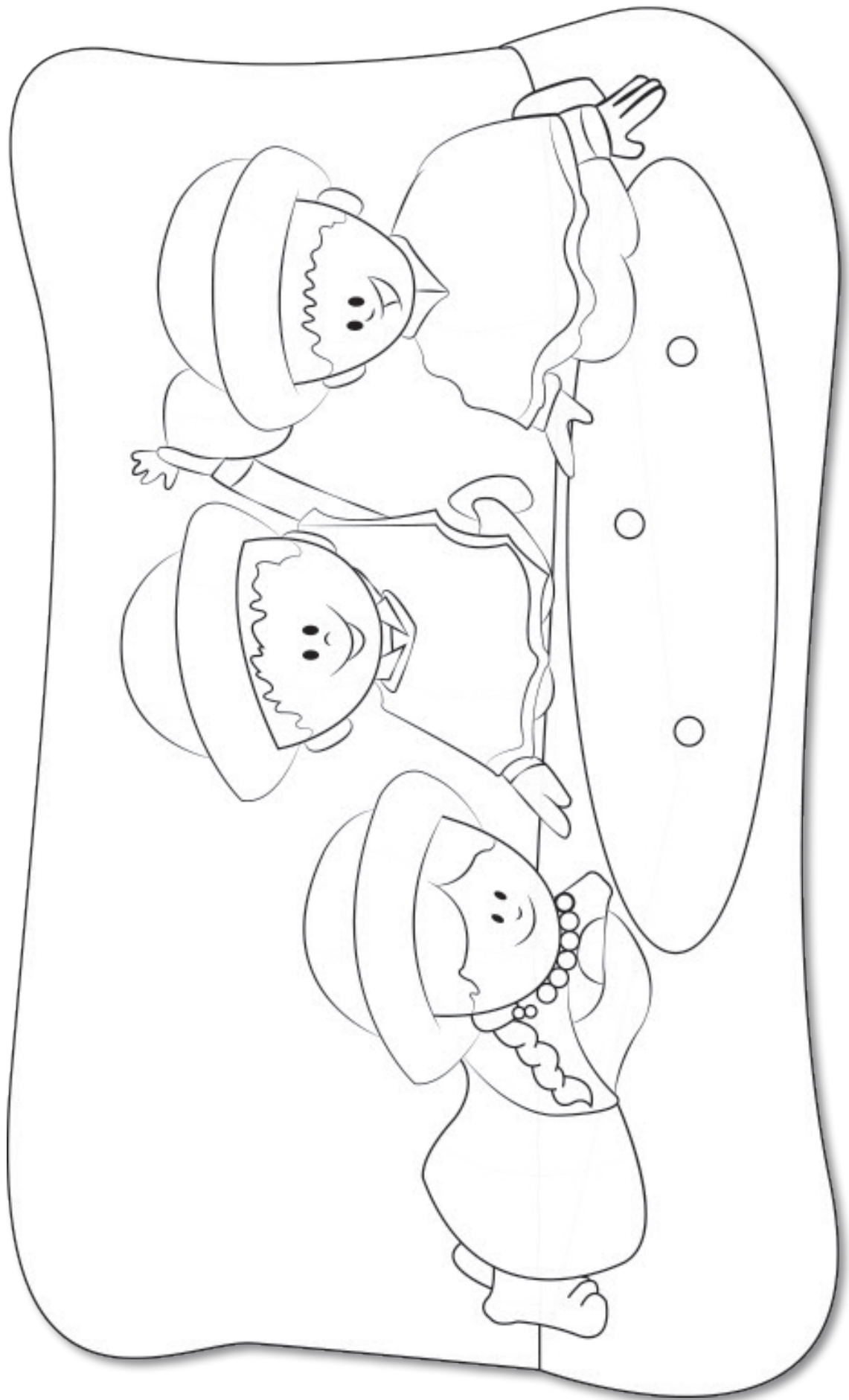

Shuti:

13 TANTACHISHKA YACHAY



Ñukanchik Ayllullakta

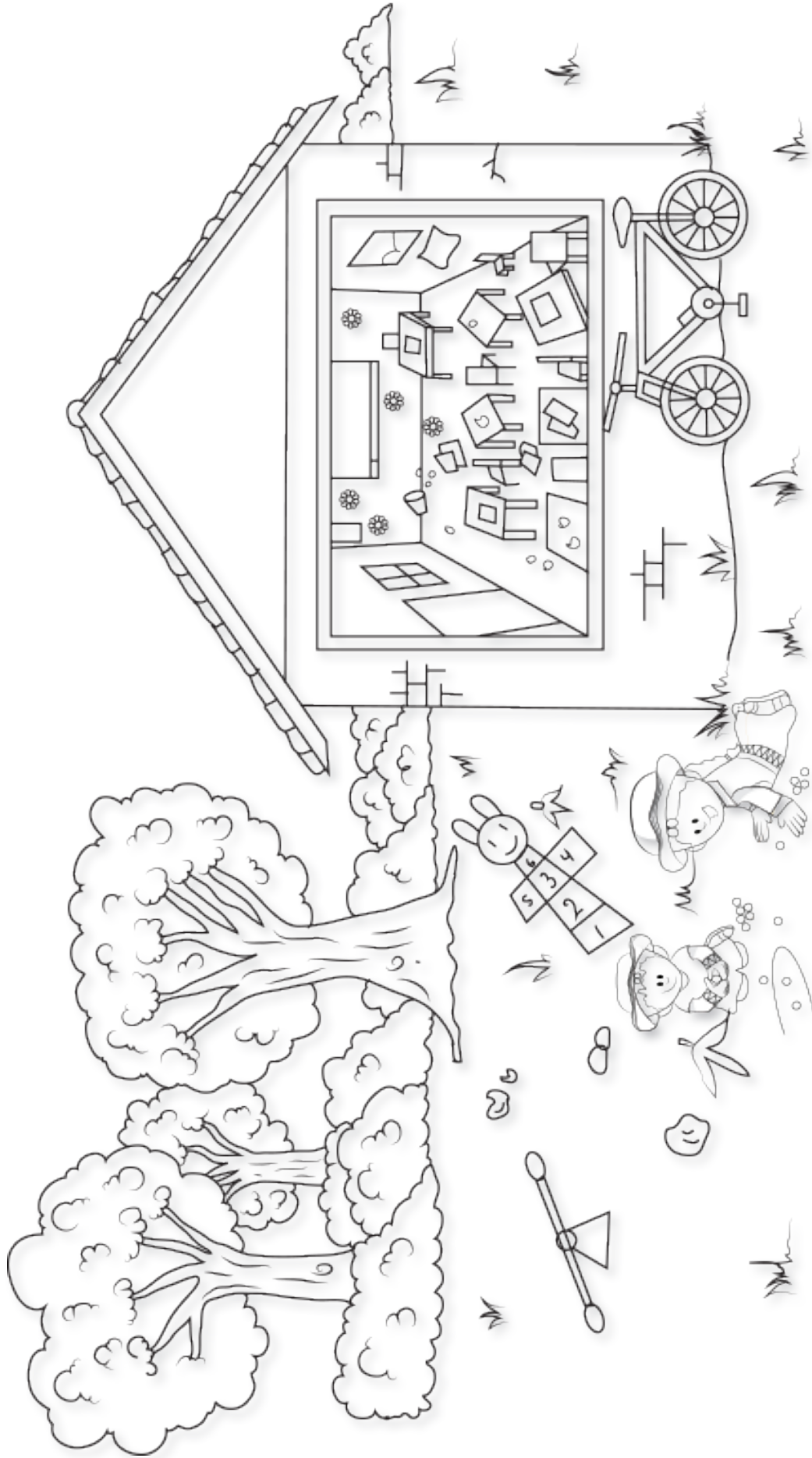

Shuti:



Shuti:

Blank space for writing the answer to the Shuti question.





Shuti:





Shuti:

Shuk rimakupika tukuykuna uyanami kan.

Mashikuna ima yuyayta nikipika allí
shunkuwan chasikinami kan.

Mashikuna urmakpikai hatarichun
yanapanami kan.

Mashipura mana makanakupashlla
pukllanachu kan.

Imanalla kanki /
kawsankichu

Achachay

Yakuka kawsaymi kan

Ananay

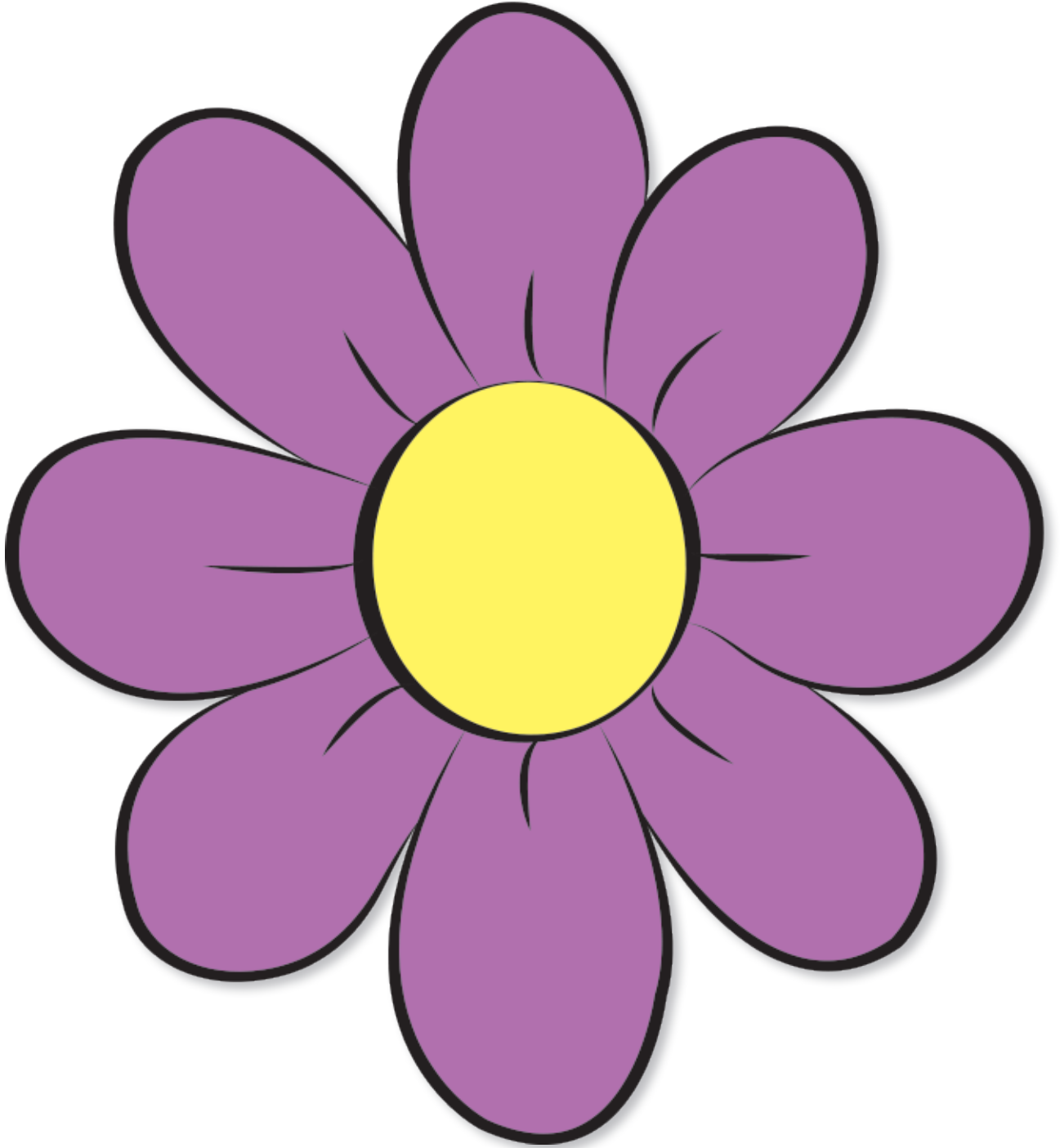

Shuti:

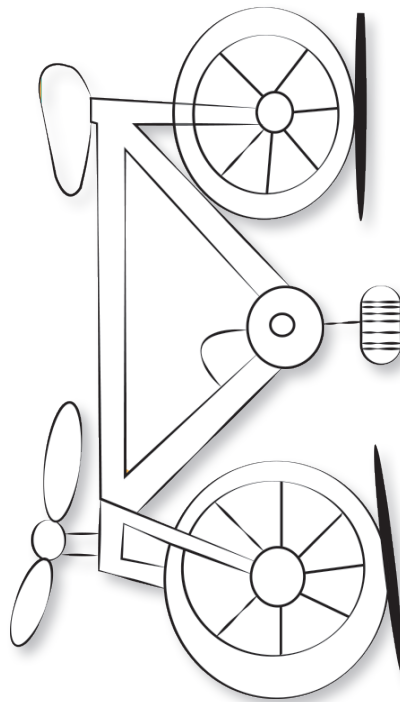
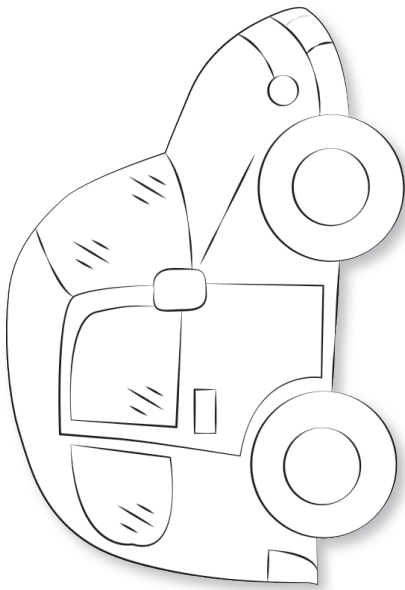
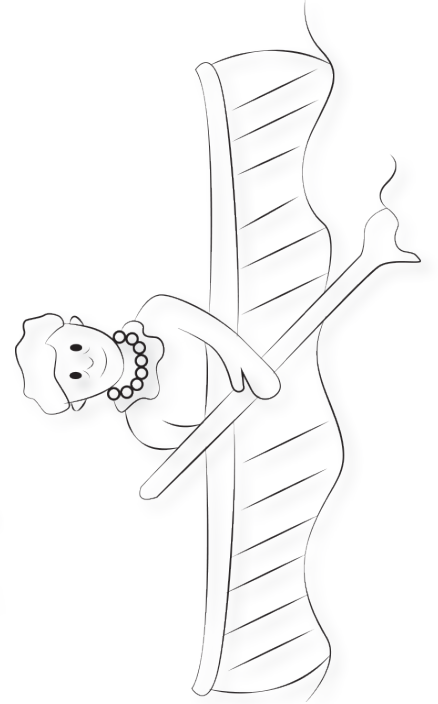
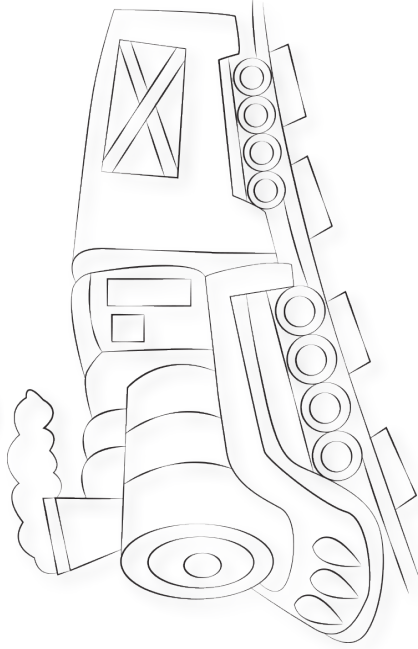
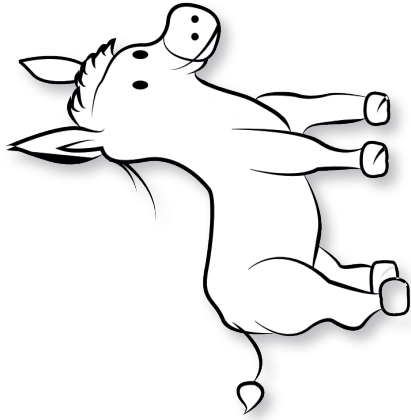

Shuti:

14 TANTACHISHKA YACHAY



Ñukanchik Kawsay

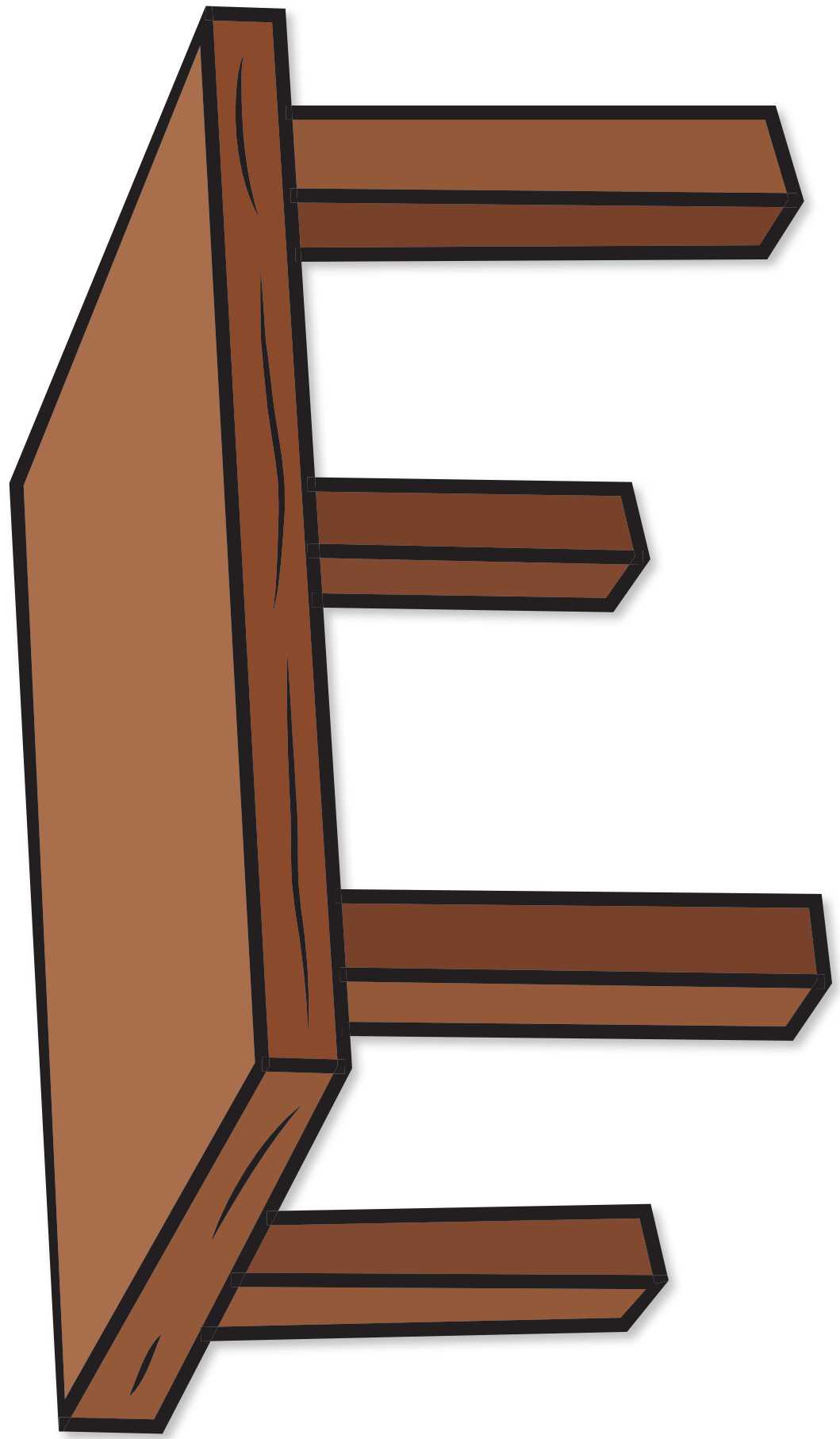

Shuti:

28 Panka

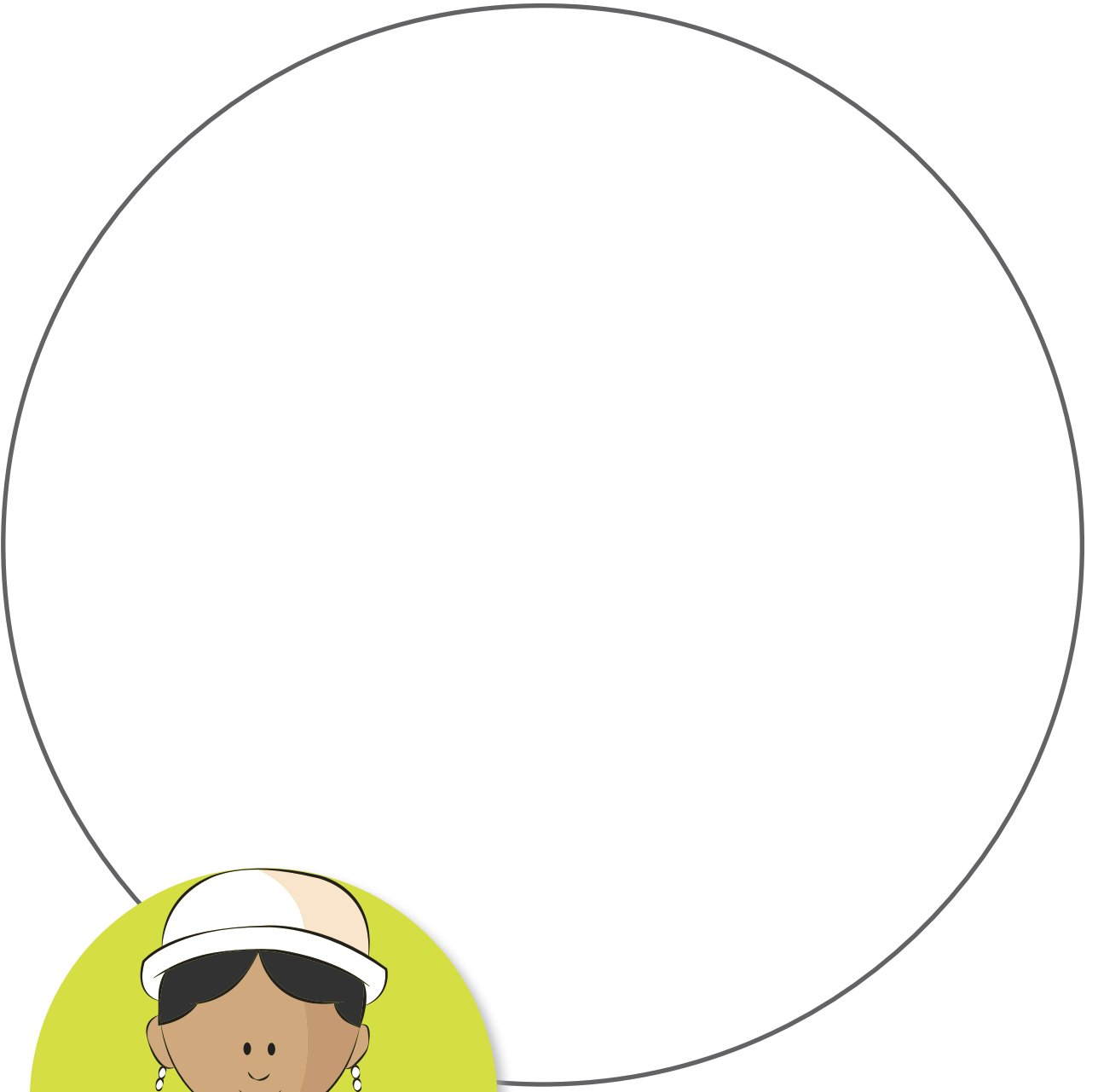

Shuti:

A rectangular box with a dashed line inside, intended for writing the answer to the question.

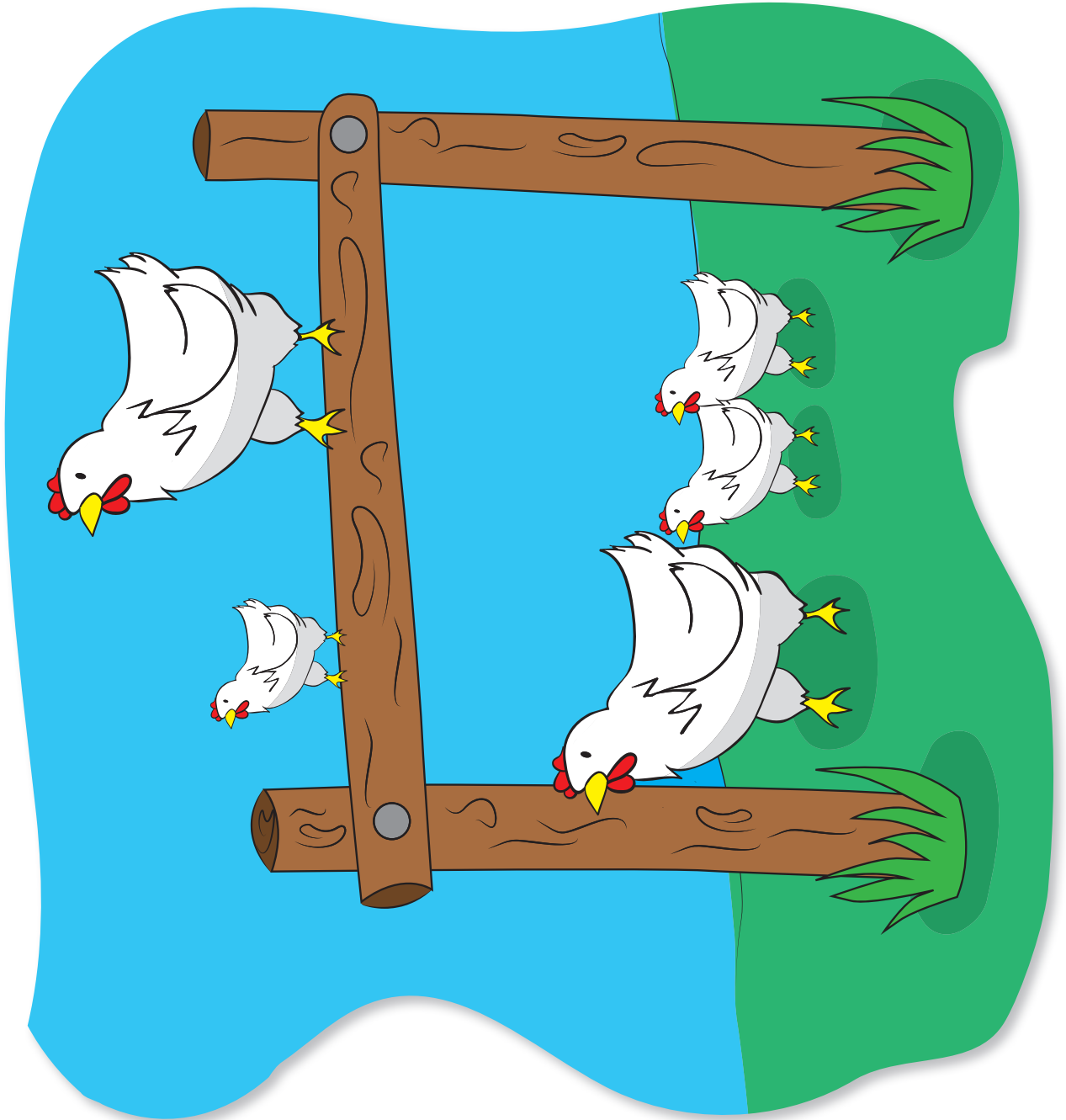

Shuti:

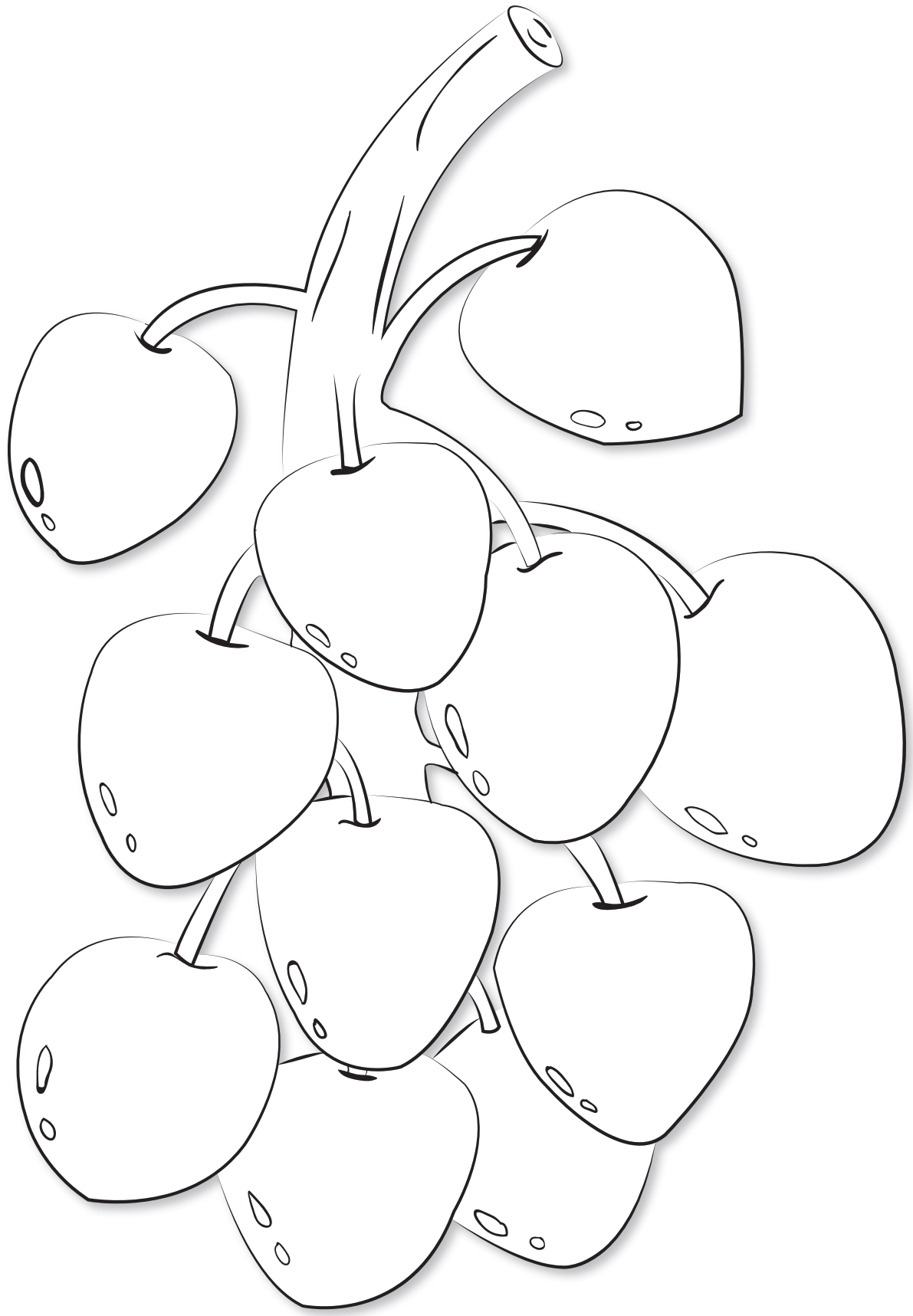

Shuti:

Wacha

Inti

Chillay

Kulla

Awaki

Chaska

Wanra

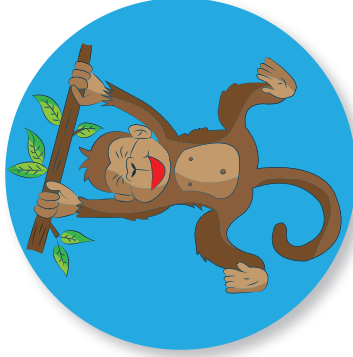

Hunkaypa
Punchakuna

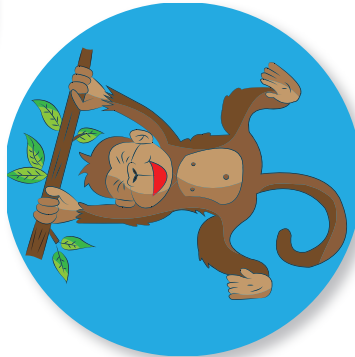

Shuti:

Blank dashed line for writing the answer.

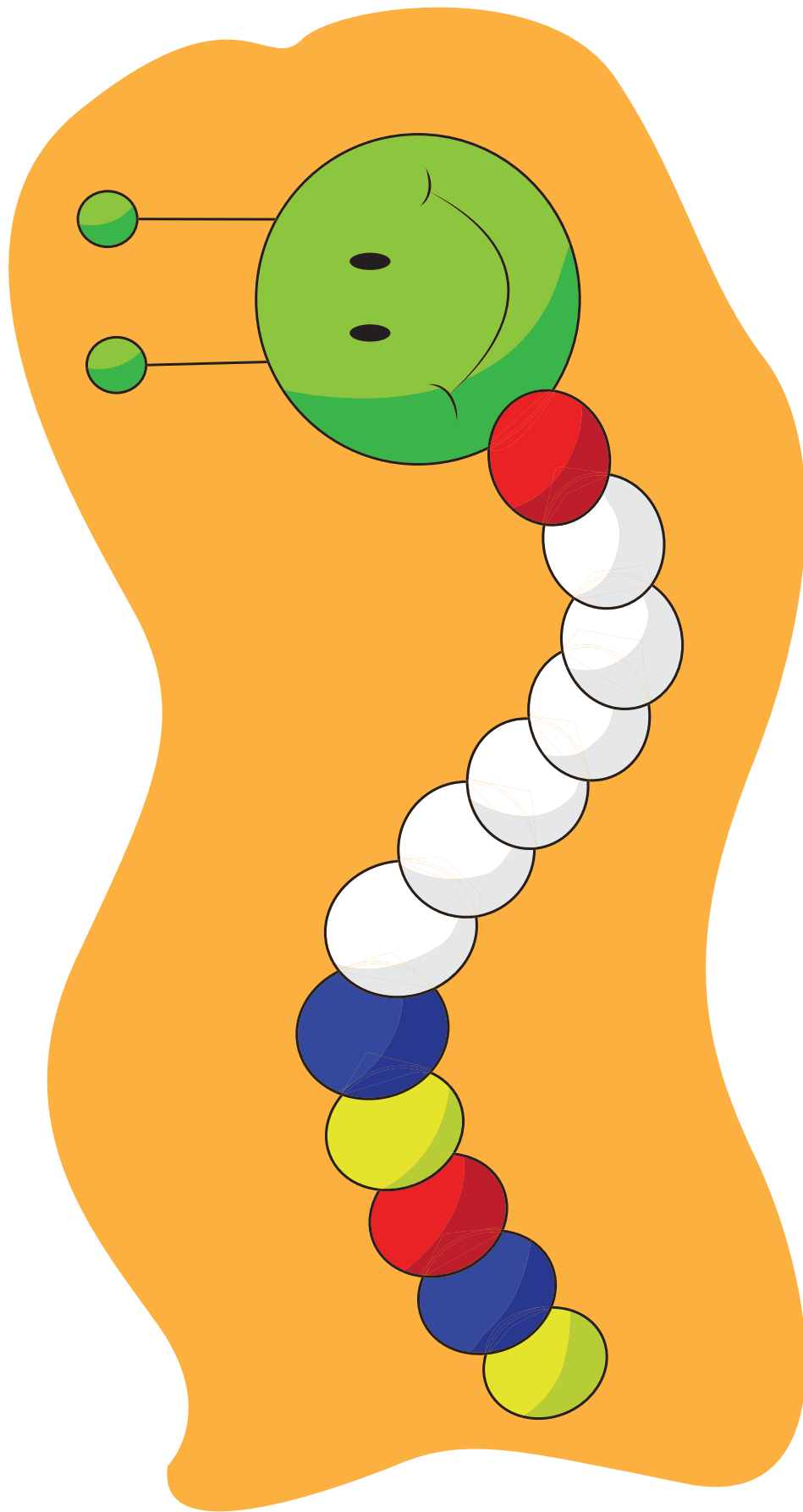

Shuti:

Blank space for writing the answer.

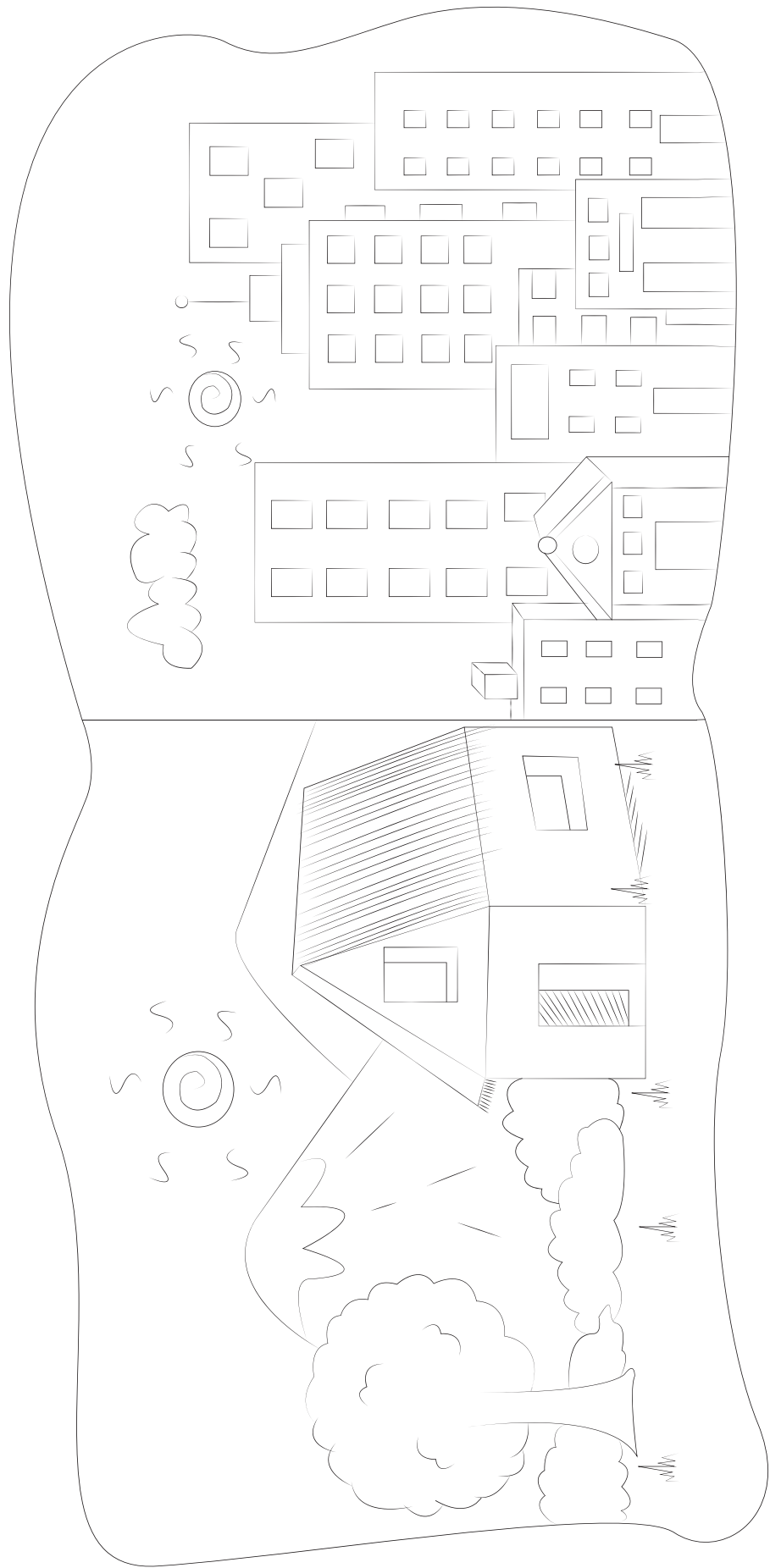

Shuti:

15 TANTACHISHKA YACHAY



Allikay Hampipash



Shuti:

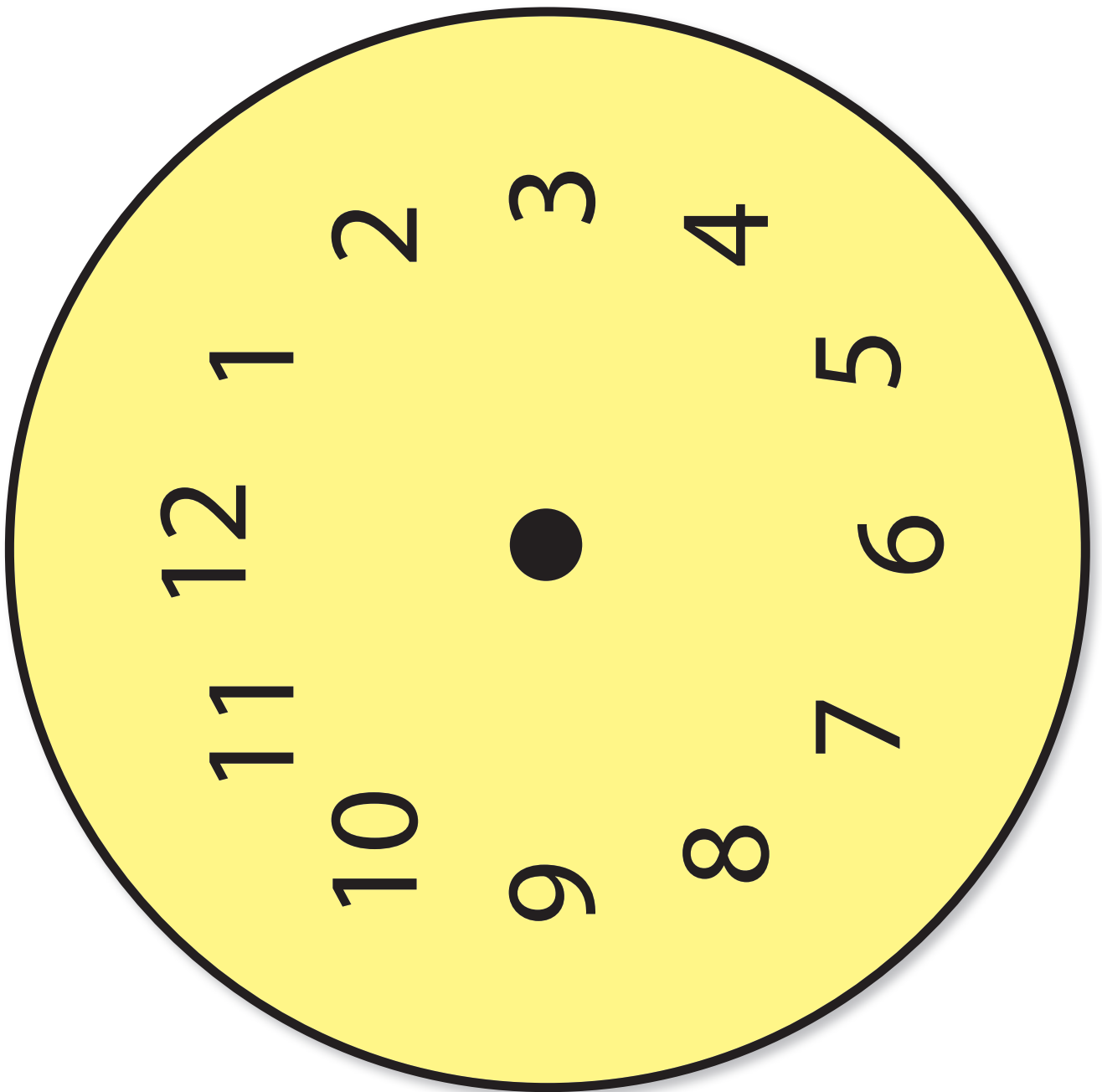

Shuti:



Shuti:

